



MATLAB Modelling of Singly Excited Induction Generator

Satyanarayana.Gorantla¹ Dr. Goli Ravi Kumar²

Associate Professor, Department of EEE, Anurag Engineering College, Kodad Research Scholar in A.N.U, Guntur
(Dt), A.P, India¹

Professor &HOD, Department of EEE,Bapatla Engineering College, Bapatla, Guntur(Dt), A.P, India²

ABSTRACT: with the extinction of conventional fuels and the global concern over increasing pollution level demands the use of renewable energy sources. Wind energy can be a good option since wind conversion system can be a supplement to support the base power from conventional power generation. The only disadvantage with singly excited induction generator (SEIG) connected to the system is consumption of reactive power. Additional reactive power compensation is required in the system. In this paper 75 Kvar reactive power compensation is installed with capacitor units. This paper presents Matlab/Modeling of singly excited induction generator showing comparative analysis of singly excited induction generator when connected a fixed load and non-linear load. Transient and steady-state results were discussed for SEIG voltages, currents and load currents. The system voltage and currents were shown along with the wind generator torque characteristics for linear and non-linear loads. Wind system with singly excited induction generator model was simulated using Matlab/Simulink software.

KEYWORDS—Singly excited Induction Generator, Wind energy, Renewable Energy Source (RES), Non-linear load .

I.INTRODUCTION

With a shortage of fossil fuels and international issues for environmental property, the demand for renewable energy is increasing steady [1-4]. Wind energy conversion system is mostly connected to the electrical grid and provides power to supplement the bottom power from different generation system victimization fuel or atomic energy. The increasing stress on renewable wind energy has given rise to increased attention on additional reliable and advantageous electrical generator systems. Wind energy is clean and endless fuel providing local economic development. Energy price stability gives wind an edge over other forms of energy sources where wind can avail modular and scalable technology. Dependency on imported fuels can be minimized with the use of wind energy to produce electrical energy. The above advantages make wind energy a prominent energy to produce electricity.

Wind power is that the conversion of wind energy into an appropriate type of energy, like victimization wind turbines to get electricity, windmills for mechanical power, wind pumps for water pumping, or sails to propel ships. the full quantity of economically removable power available from the wind is significantly quite gift human power use from all sources. Wind power, as an alternate to fossil fuels, is copious, renewable, wide unfold, clean, and produces no gas emissions throughout operation. Alternative energy is that the worlds speedy growing supply of energy. The majority of electricity is generated by burning coal, instead of additional eco-friendly methods like electricity power. This use of coal causes much environmental injury through dioxide and differently deadly emissions. The energy sector is far and away the largest supply of those emissions, each within the Bharat and globally, and if we have a tendency to square measure to tackle global climate change it's clear we'd like to maneuver far from burning restricted fuel reserves to additional property and renewable sources of energy.

The line diagram of singly excited induction generator [5-8] producing electrical energy was shown in figure 1. Line diagram consists of SEIG connected to grid and capacitors to compensate reactive power. Induction generator systems are widely used and studied in wind generation system as a result of their benefits synchronous generators. Induction generator could be asynchronous generator; it's a sort of AC electrical generator. Induction generators operate by automatically turning their rotor quicker than the synchronous speed. This area unit is helpful in applications like mini hydro power plants and wind turbines. Induction generators are electrically easier than different generator types. Induction generators are significant for wind generating stations as during this case speed is usually a

International Journal of Advanced Research in Electrical, Electronics and Instrumentation Engineering

(An ISO 3297: 2007 Certified Organization)

Vol. 5, Issue 6, June 2016

variable issue. In contrast to synchronous motors, induction generators are load dependent and can't be used higher than for grid frequency management. Another major drawback with SEIG grid is that the supply of reactive power [9-11]. For standalone or autonomous operation, largely single induction generator or parallel operated induction generators square measure centered in line with out there analyzed references. This induction generator driven by the individual prime movers utilizes excitation electrical device bank to create up desired voltage via self-excited phenomena. Thence the worth of the excitation electrical device bank and therefore the rotor speed confirm the magnitude of the generated voltage and its frequency. Each voltage and frequency has to be compelled to be controlled to feed the ability to the load [12-14].

This paper presents Matlab/Modeling of singly excited induction generator showing comparative analysis of singly excited induction generator when connected a fixed load and non-linear load. Transient and steady-state results were discussed for SEIG voltages, currents and load currents. The system voltage and currents were shown along with the wind generator torque characteristics for linear and non-linear loads. Mathematical modelling was shown for induction motor model and results were discussed in the sub-sequent part of the paper.

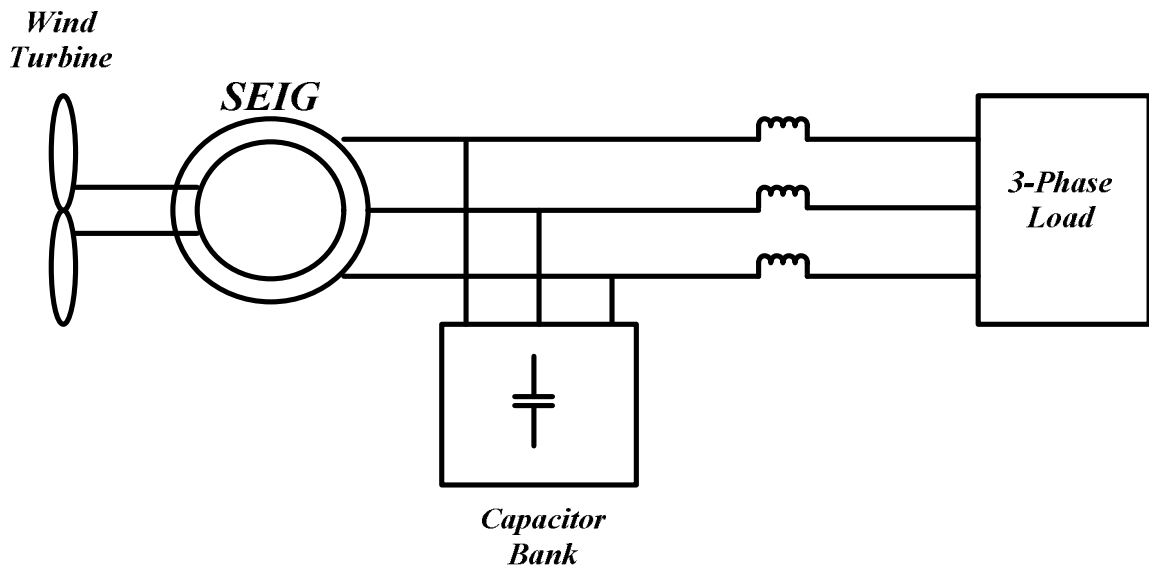

Fig.1:Line diagram of Wind energy system with SEIG

II. DYNAMIC MODELLING OF SEIG

The equivalent circuit diagram of an induction machine is shown in Fig.2 and Fig.3. In this figure the machine is represented as two phase machine, it has already been discussed before that a three phase machine can be represented as two phase machine obeying certain rules. For the modelling of SEIG in synchronously rotating frame we need to represent the two phase stator (ds -q s) and rotor (dr -q r) circuit variables in a synchronously rotating (d-q) frame.

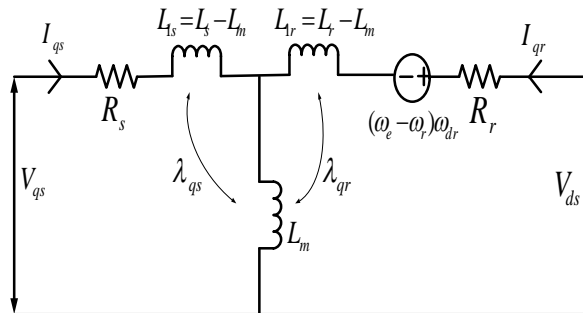

Fig.2: Dynamic equivalent circuit of SEIG (q-axis circuit)

International Journal of Advanced Research in Electrical, Electronics and Instrumentation Engineering

(An ISO 3297: 2007 Certified Organization)

Vol. 5, Issue 6, June 2016

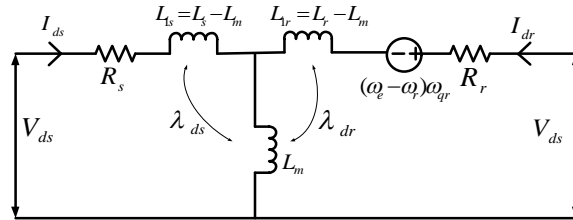

Fig.3: Dynamic equivalent circuit of SEIG (d-axis circuit)

The stator circuit equations are given by

$$V_s^r = R_s i_s^r + \frac{d\lambda_s^r}{dt} + J\omega_k \lambda_s^r \quad (1)$$

$$V_r^r = R_r i_r^r + \frac{d\lambda_r^r}{dt} + J(\omega_k - \omega_r) \lambda_r^r \quad (2)$$

where,

v_s^r, v_r^r = Stator and rotor voltage space vectors,
 λ_s^r, λ_r^r = Stator and rotor flux linkage space vectors,
 i_s^r, i_r^r = Stator and rotor current space vectors and
 ω_r = Rotor angular speed.

$$\lambda_s^r = L_s i_s^r + L_m i_r^r \quad (3)$$

$$\lambda_r^r = L_m i_s^r + L_r i_r^r \quad (4)$$

where,

L_s = Stator inductance,
 L_r = Rotor inductance
 L_m = Mutual inductance.

$$\frac{d\lambda_s^r}{dt} = v_s^r - \frac{R_s}{K} (L_r \lambda_r^r - L_m \lambda_s^r) - J\omega_k \lambda_s^r \quad (5)$$

$$\frac{d\lambda_r^r}{dt} = v_r^r - \frac{R_r}{K} (L_s \lambda_s^r - L_m \lambda_r^r) - J(\omega_k - \omega_r) \lambda_r^r \quad (6)$$

where, $K = L_s L_r - L_m^2$

The flux linkage expression can be given as,

$$\frac{d}{dt} \begin{bmatrix} \lambda_{ds} \\ \lambda_{qs} \\ \lambda_{dr} \\ \lambda_{qr} \end{bmatrix} = \begin{bmatrix} \frac{-R_s L_r}{K} & \omega_k & \frac{-R_s L_m}{K} & 0 \\ -\omega_k & \frac{-R_s L_r}{K} & 0 & \frac{-R_s L_m}{K} \\ \frac{-R_r L_m}{K} & 0 & \frac{-R_r L_s}{K} & (\omega_k - \omega_r) \\ 0 & \frac{-R_r L_m}{K} & -(\omega_k - \omega_r) & \frac{-R_r L_s}{K} \end{bmatrix} \begin{bmatrix} \lambda_{ds} \\ \lambda_{qs} \\ \lambda_{dr} \\ \lambda_{qr} \end{bmatrix} + \begin{bmatrix} V_{ds} \\ V_{qs} \\ V_{dr} \\ V_{qr} \end{bmatrix} \quad (7)$$

The torque expression is given by,

$$T_e = \frac{3pL_m}{2L_s} (\lambda_s^r i_r^{*r}) \quad (8)$$

III. SYSTEM DESCRIPTION

The planned system consists of wind turbine as prime mover which is coupled to an induction motor (SEIG). The output is fed to the loads. The system is considered to have linear and non-linear loads. The capacitor bank is installed to the line to act for power factor correction. The system line diagram was shown in figure 1. The stable operation of the system can be sustained at any moment when the balance of real power and reactive power can be maintained. The balance of real power is established mainly between the power produced in the rotor and the power consumed from the

International Journal of Advanced Research in Electrical, Electronics and Instrumentation Engineering

(An ISO 3297: 2007 Certified Organization)

Vol. 5, Issue 6, June 2016

stator winding through the power converter. The balanced of reactive power is established between the ac capacitors and the air-gap flux condition at any operating condition.

IV. MATLAB/SIMULINK RESULTS AND DISCUSSIONS

Matlab/Simuink results were considered for linear load and non-linear load fed from SEIG.

A) Dynamic Modeling of SEIG:

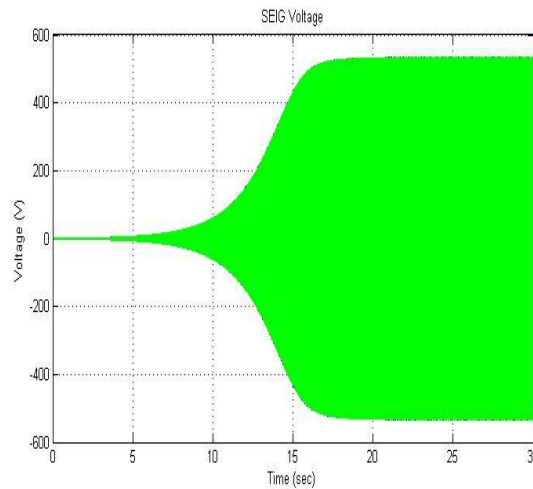

Fig.4: Transient response of SEIG voltages

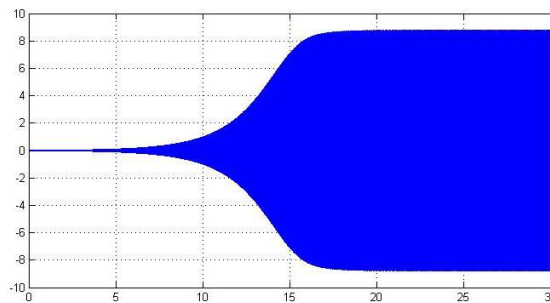

Fig.5: Transient response of SEIG stator currents

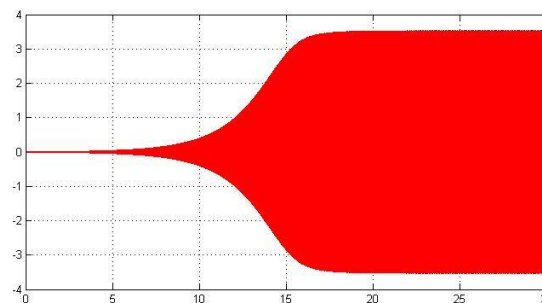

Fig.6: Transient response of SEIG load currents

Figure 4 shows the transient response of voltages of SEIG while figure 5 shows the transient response of SEIG stator currents. Figure 6 shows the transient behavior of load currents connected to SEIG.

International Journal of Advanced Research in Electrical, Electronics and Instrumentation Engineering

(An ISO 3297: 2007 Certified Organization)

Vol. 5, Issue 6, June 2016

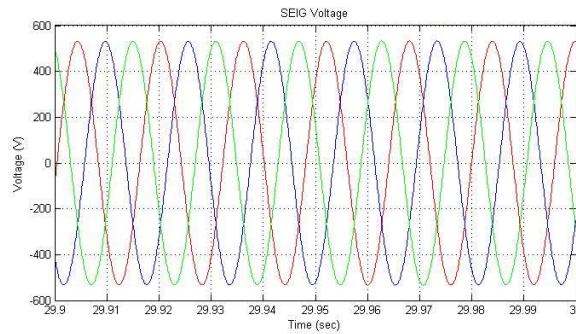

Fig.7: Steady-state response of SEIG voltages

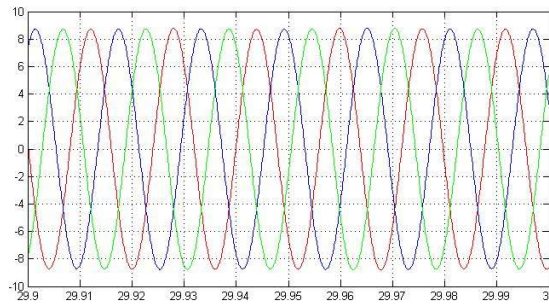

Fig.8: Steady-state response of SEIG stator currents

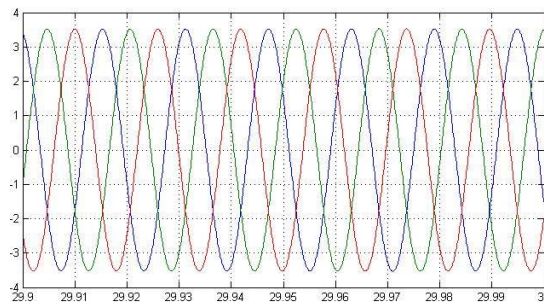

Fig.9: Steady-state response of SEIG load currents

Figure 7 shows the steady-state response of voltages of SEIG while figure 8 shows the steady-state response of SEIG stator currents. Figure 9 shows the steady-state behavior of load currents connected to SEIG.

B) Physical Modeling of SEIG Case 1: SEIG with linear load

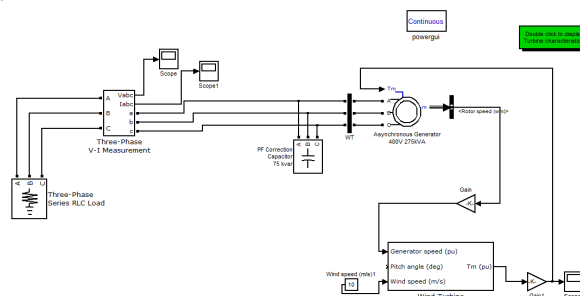

Fig.10: Matlab/Simulink model of system with SEIG having linear load.

International Journal of Advanced Research in Electrical, Electronics and Instrumentation Engineering

(An ISO 3297: 2007 Certified Organization)

Vol. 5, Issue 6, June 2016

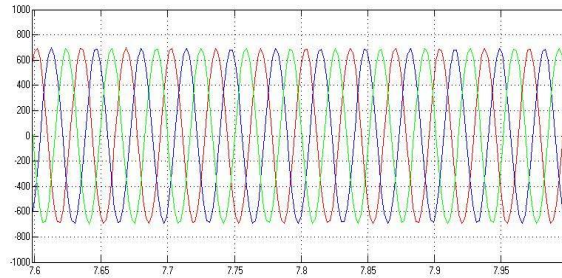

Fig.11: Simulink result of system line voltages

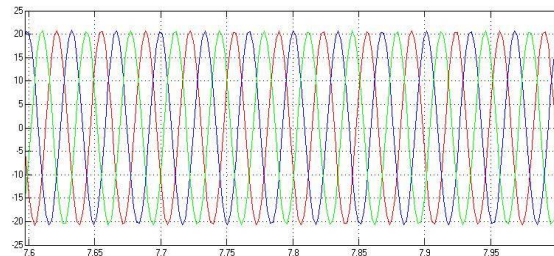

Fig.12: Simulink result of system line currents

Figure 10 shows the Matlab/Simulink model of SEIG connected system having linear loads. Figure 11 shows the line voltages and figure 12 shows the line currents of the system.

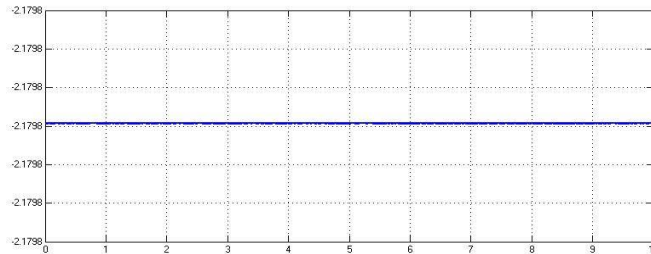

Fig.13: Simulink result of SEIG Torque characteristics

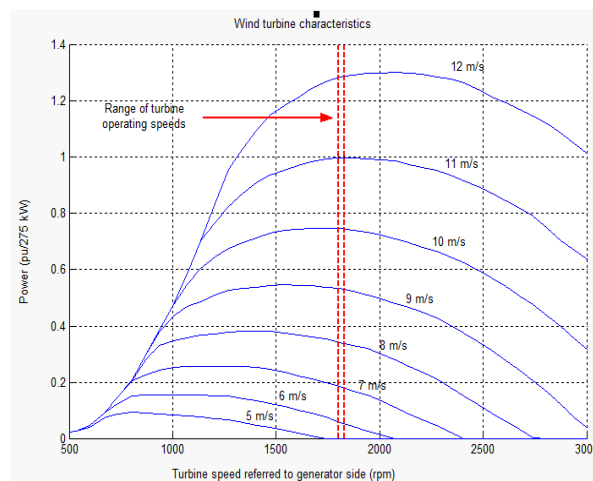

Fig.14: Simulink result of Wind Turbine Characteristics

International Journal of Advanced Research in Electrical, Electronics and Instrumentation Engineering

(An ISO 3297: 2007 Certified Organization)

Vol. 5, Issue 6, June 2016

Figure 13 shows the torque characteristics of SEIG while figure 14 shows the wind turbine characteristics.
Case 2: SEIG with non-linear load

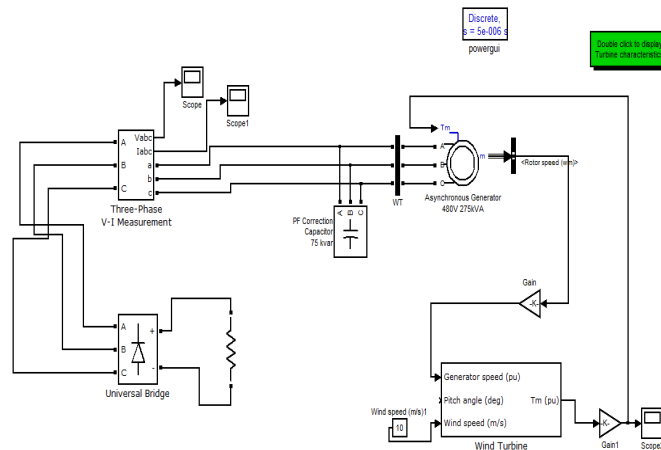

Fig.15: Matlab/Simulink model of system with SEIG having non-linear load

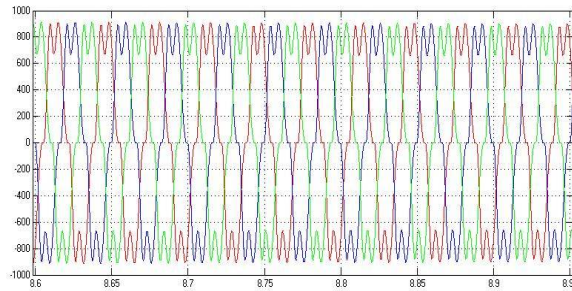

Fig.16: Simulink result of system line voltages

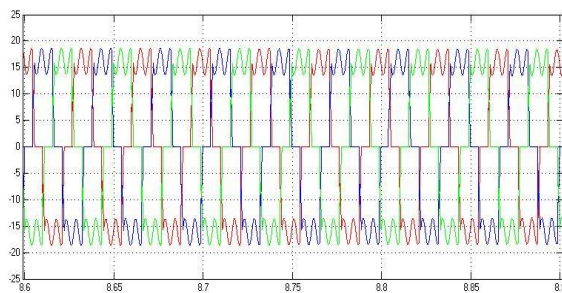

Fig.17: Simulink result of system line currents

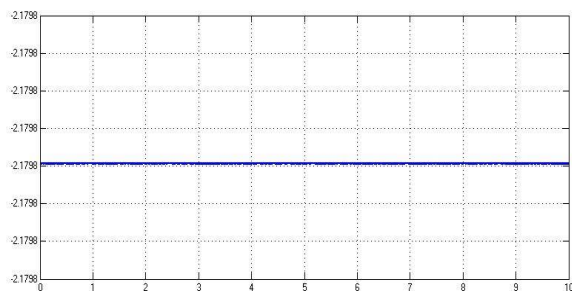

Fig.18: Simulink result of SEIG Torque characteristics



International Journal of Advanced Research in Electrical, Electronics and Instrumentation Engineering

(An ISO 3297: 2007 Certified Organization)

Vol. 5, Issue 6, June 2016

Figure 15 shows the Matlab/Simulink model of SEIG connected system having non-linear loads. Figure 16 shows the line voltages and figure 17 shows the line currents of the system. Results clearly indicates the content of harmonic distortions in the voltages and current waveforms due to the presence of non-linear loads connected to SEIG. Figure 18 shows the torque characteristics of SEIG.

V.CONCLUSION

Wind energy can be a good option since wind conversion system can be a supplement to support the base power from conventional power generation. Matlab modeling of singly excited induction generator showing comparative analysis of singly excited induction generator when connected a fixed load and non-linear load were shown and discussed. Transient and steady-state results were discussed for SEIG voltages, currents and load currents. The system voltage and currents were shown along with the wind generator torque characteristics for linear and non-linear loads. there is a scope to take measures to limit THD produced in voltages and currents when SEIG is connected to non-linear loads.

REFERENCES

- [1] M.L. Elhafyani, S. Zouggar, Y. Zidani and M. Benkaddour, "Permanent and Dynamic Behaviours of Selfexcited Induction Generator in Balanced Mode", M. J. Condensed Mater, Vol. 7, pp. 49 - 53, 2006.
- [2] Ahmed, T.; Nishida, K.; Nakaoka, M.; Tanaka „Advanced Control of a Boost ACDC PWM Rectifier for Variable-Speed Induction Generator", Applied Power Electronics Conference and Exposition, 2006. APEC '06. Twenty First Annual IEEE 956-962 March 19, 2006.
- [3] Seyoum D., Grantham C. and Rahman F, "Analysis of an Isolated SelfExcited Induction Generator Driven by Variable Speed Prime Mover", Proc.AUPEC'01, 2001, pp. 49-54
- [4] Karim H. Youssef, Manal A. Wahba, Hasan A. Yousef and Omar. A. Sebakhy „A New Method for Voltage and Frequency Control of StandAlone Self-Excited Induction Generator Using PWM Converter with Variable DC link Voltage""2008 American Control Conference Westin Seattle Hotel, Seattle, Washington, USA June 11-13, 2008
- [5] M.L. Elhafyani , S. Zouggar , A. Aziz et M. Benkaddour"" Conception et modélisation d'un système éolien contrôlé par un régulateur de tension"" Revue des Energies Renouvelables CER'07 Oujda (2007) 41 – 45.
- [6] Debta, Birendra Kumar and Mohanty, K.B., "Analysis on the effect of dynamic mutual inductance in voltage build up of a stand-alone brushless asynchronous generator", Procc. of National Power Electronics Conference, IIT Roorkee, June 2010. 0 1 2 3 4 5 6 7 0 50 100 150 200 250 300 350 DC voltage t(s) Recent Advances in Electrical and Computer Engineering ISBN: 978-1-61804-228-6 148
- [7] Mohamed barara Ahemd Abbou Mohammed Akherraz and abderrahim Bennasar, "Modeling and Control Voltage of Wind Pumping Systems using a Self Excited Induction Generator,,, International Journal on Electrical Engineering and Informatics - Volume 5, Number 2, June 2013
- [8] Kai wan., Advancd current-mode control techniques for DC-DC Power electronic converter, PhD Thesis, MISSOURI UNIVERSITY OF SCIENCE & TECHNOLOGY ,2009
- [9] Soltane BELAKEHAL ,Conception & Commande des Machines à Aimants Permanents Dédiées aux Energies Renouvelables,,PhD Thesis,UNIVERSITE DE CONSTANTINE
- [10] Sonam Singh, A.N Tiwari, "Voltage And Frequency Controller For Self Excited Induction Generator In Micro Hydro Power Plant: Review", International Journal of Advanced Research in Electronics and Communication Engineering (IJARECE) Volume 2, Issue 2, February 2013
- [11] B.BOSSOUFI, M.KARIM, S.IONITA, A.LAGRIOUI, "Low-Speed Sensorless Control of PMSM Motor drive Using a NONLINEAR Approach BACKSTEPPING Control: FPGA-Based Implementation" Journal of Theoretical and Applied Information Technology JATIT, pp154-166, Vol. 36 No.1, 29th February 2012.
- [12] El -Sousy, F. F. M., Orabi, M., & Godah, H. (2006). Maximum Power Point TrackingControl Scheme for Grid Connected Variable Speed Wind Driven Self-Excited InductionGenerator. Journal of Power Electronics (JPE), 6(1), 52-66.
- [13] L. Louze, A.L. Nemmour, A. Khezzar, M.E. Hacil and M. Boucherma"" Cascade sliding mode controller for self-excited induction generator "" Revue des Energies Renouvelables Vol. 12 N°4 (2009) 617 – 626.
- [14] A.M. BOUZIDA, M. BENGHANEM, B.HAMANEC, A.BELABBES, M.BOUHAMIDA, A.DRAO, " Current Control of the Isolated Self Excited Induction Generator using Shunt Active Filter"" Energy Procedia 18 (2012) 349 – 358.