



ISSN (Print) : 2320 – 3765
ISSN (Online): 2278 – 8875

International Journal of Advanced Research in Electrical, Electronics and Instrumentation Engineering

(An ISO 3297: 2007 Certified Organization)

Vol. 5, Issue 6, June 2016

A Comparative Analysis of SVC, STATCOM and UPFC for Voltage Regulation in Power System

Paramvir Sheoran, Pawan Kumar Pandey, Vikrant Kumar

M.Tech Student, Department of EEE, BRCM College of Engineering, Behal, Bhiwani Haryana, India

Asst. Professor, Department of EEE, BRCM College of Engineering, Behal, Bhiwani Haryana, India

Asst. Professor, Department of EEE, BRCM College of Engineering, Behal, Bhiwani Haryana, India

ABSTRACT: In this paper a comparative analysis between various FACTS Devices in Power System has been carried out. In a power system network consisting of generators, transmission lines, transformers and load etc., STATCOM, SVC and UPFC are applied between two buses separately and their effects are analyzed as per applied system conditions. Power flow between different buses and voltage regulation of above FACTS devices is found out. Simulation of the system was carried out in MATLAB environment.

In this analysis system was simulated by introducing reference power at the bus where UPFC is connected. UPFC injects series voltage in line and follows reference power as required. SVC and STATCOM are simulated in voltage regulation mode where a reference voltage is given at the bus to which they are connected. Their voltage regulation capabilities and reactive power compensation ability is analyzed.

KEYWORDS: Voltage regulation, STATCOM, SVC, UPFC, Power system.

I. INTRODUCTION

Transmission lines in congested areas are often driven increased electric power consumption and trades. Thus, secure operation and reliable supply is endangered by the higher risks for faulted lines. FACTS devices are able to influence power flows and voltages to different degrees depending on the type of the device. If the reactive power of the load is changing rapidly, then a suitable fast response compensator is needed. Static VAR Compensator (SVC) thyristor control series compensator (TCSC) and thyristor control phase shift transformer (TCPST) is such a compensator which belongs to FACTS family. The ultimate objective of applying reactive shunt compensation in the line is to improve the voltage profile. The inclusion of the FACTS devices in the circuit improves the reactive power in the line. FACTS are successfully simulated and the results show the voltage profile improvement.

Flexible alternating current transmission systems (FACTS) technology opens up new opportunities for controlling power and enhancing the usable capacity of present, as well as new and upgraded lines. The Unified Power Flow Controller (UPFC) is a second generation FACTS device, which enables independent control of active and reactive power besides improving reliability and quality of the supply.

The power flow over a transmission line depends mainly on three important parameters, namely voltage magnitude of the buses (V), impedance of the transmission line (Z) and phase angle between buses (θ). The FACTS devices control one or more of the parameters to improve system performance by using placement and coordination of multiple FACTS controllers in large-scale emerging power system networks to also show that the achieve significant improvements in operating parameters of the power systems such as small signal stability, transient stability, damping of power system oscillations, security of the power system, less active power loss, voltage profile, congestion management, quality of the power system, efficiency of power system operations, power transfer capability through the lines, dynamic performances of power systems, and the load ability of the power system network also increased. As FACTS devices are fabricated using solid state controllers, their response is fast and accurate. Thus these devices can be utilized to



ISSN (Print) : 2320 – 3765
ISSN (Online): 2278 – 8875

International Journal of Advanced Research in Electrical, Electronics and Instrumentation Engineering

(An ISO 3297: 2007 Certified Organization)

Vol. 5, Issue 6, June 2016

improve the voltage profile of the system by using coordinated control of FACTS controllers in multi-machine power systems in this work.

II. LITERATURE REVIEW

FACTS devices control one or more of the parameters [1, 2]. They improve system performance by using placement and coordination of multiple FACTS controllers in large-scale emerging power system networks to also show that they achieve significant improvements in operating parameters of the power systems such as small signal stability, transient stability, damping of power system oscillations, security of the power system, less active power loss, voltage profile, congestion management, quality of the power system, efficiency of power system operations, power transfer capability through the lines, dynamic performances of power systems, and the load ability of the power system network also increased [3,4].

Detailed information about the development of FACTS technologies is presented in [3, 4, 5, and 6]. Introduction to FACTS devices, voltage profile improvement, power system operation and control and comparison of different FACTS devices is presented in [1, 2, 5, and 6]. UPFC controls active and reactive power independently and it can also control step like changes in P and Q.

Basic Unified Power Flow Controller approach to Power Transmission Control is presented in [7]. Modeling of UPFC is done separately for shunt and series converters. Modeling of UPFC is studied from [8, 9].

UPFC can be connected to a bus where control of active and reactive power is desired. Interfacing and control strategy of UPFC is presented in [8]. FACTS devices improve voltage under severe fault conditions. They supply reactive power during fault conditions. Transient Simulation of FACTS in multi machine power systems is studied from [10]. UPFC enables independent control of active and reactive power besides improving reliability and quality of the supply [11].

Modelling of UPFC is done using d-q axis theory quite easily. Modelling of shunt and series UPFC system is done. Shunt control system and series control system is designed for analysis of UPFC. Performance of a unified power flow controller using a D-Q control system AC and DC power transmission is studied from [12]. Performance of UPFC on System Behavior under Fault Conditions is presented in [13].

Transmission lines are of two types. Single circuit transmission lines and double circuit. Transmission line designing is very important aspect of power system. Designing of EHV lines is studied from [14].

The UPFC is the most versatile and complex power electronic equipment that has emerged for the control and optimization of power flow in electrical power transmission systems. It offers major potential advantages for the static and dynamic operation of transmission lines, but it brings with it major design challenges, both in the power electronics and from the perspective of the power system [14, 15]. As the UPFC transitions from concept to full-scale power system implementation, the control and protection of this sophisticated equipment are of primary concern [15]. UPFC theory, modelling, and applications are studied from [16, 17].

The best place for UPFC for loss reduction is in the main transmission lines. The loss reduction can be achieved by two methods. First, by increasing the transition power in lines which have low impedance; Second, by decreasing the transmission power in lines with high impedance [18]. UPFC control is designed in such a way that not only regulates the voltage but also regulates the current, active and reactive power [19, 20]. It can also reduce the harmonics in the system and improves the overall harmonic distortion level. It is designed as such that it does not cause high swings in the dc capacitor voltage and the simulation results prove it [19, 20, 21, and 22].

III. MODELLING OF SVC, STATCOM AND UPQC

A. Modelling of SVC

SVC is a first generation FACTS controller that is already in operation at various places in the world. In its simplest form it uses a thyristor controlled reactor (TCR) in conjunction with a fixed capacitor (FC) or thyristor switched capacitor (TSC). A pair of opposite poled thyristors is connected in series with a fixed inductor to form a TCR module while the thyristors are connected in series with a capacitor to form a TSC module Figure 1 shows the Simulink diagram of SVC. SVC can control the voltage magnitude at the required bus thereby improving the voltage profile of the system. The primary task of an SVC is to maintain the voltage of a particular bus by means of reactive power



International Journal of Advanced Research in Electrical, Electronics and Instrumentation Engineering

(An ISO 3297: 2007 Certified Organization)

Vol. 5, Issue 6, June 2016

compensation (obtained by varying the firing angle of the thyristors). It can also provide increased damping to power oscillations and enhance power flow over a line by using auxiliary signals such as line active power, line reactive power, line current, and computed internal frequency. Static VAR Compensator (SVC) is a shunt connected FACTS controller whose main functionality is to regulate the voltage at a given bus by controlling its equivalent reactance. Basically it consists of a fixed capacitor (FC) and a thyristor controlled reactor (TCR).
B. Modelling of STATCOM

B. Modelling of STATCOM

The Static Synchronous Compensator (STATCOM) is a shunt device of the Flexible AC Transmission Systems (FACTS) family using power electronics to control power flow and improve transient stability on power grids. The STATCOM regulates voltage at its terminal by controlling the amount of reactive power injected into or absorbed from the power system. When system voltage is low, the STATCOM generates reactive power (STATCOM capacitive). When system voltage is high, it absorbs reactive power (STATCOM inductive). The variation of reactive power is performed by means of a Voltage Sourced Converter (VSC) connected on the secondary side of a coupling transformer. The VSC uses forced-commutated power electronic devices (GTOs, IGBTs or IGCTs) to synthesize a voltage V_2 from a DC voltage source. The principle of operation of the STATCOM is explained on the Figure 2 below showing the active and reactive power transfer between a source V_1 and a source V_2 . In this figure, V_1 represents the system voltage to be controlled and V_2 is the voltage generated by the VSC.

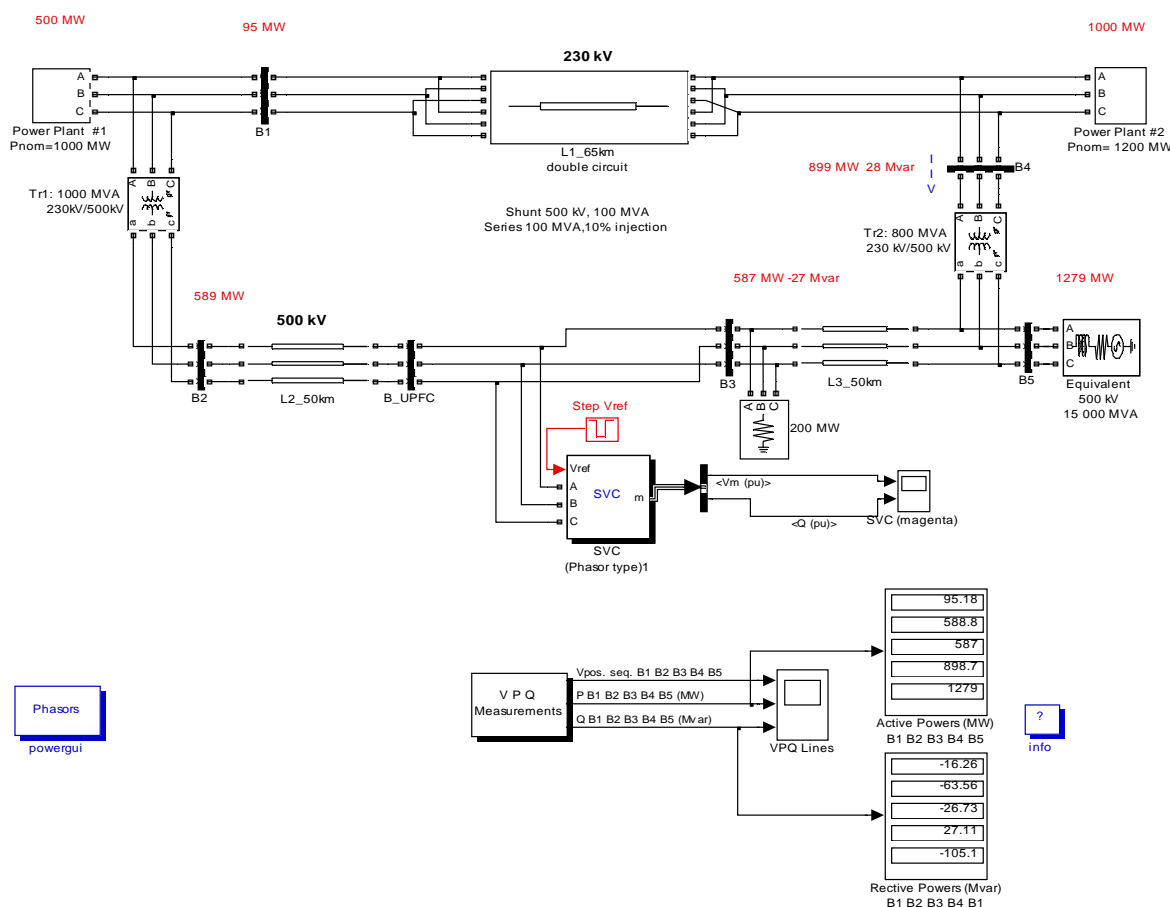

Fig. 1. Simulink model of SVC

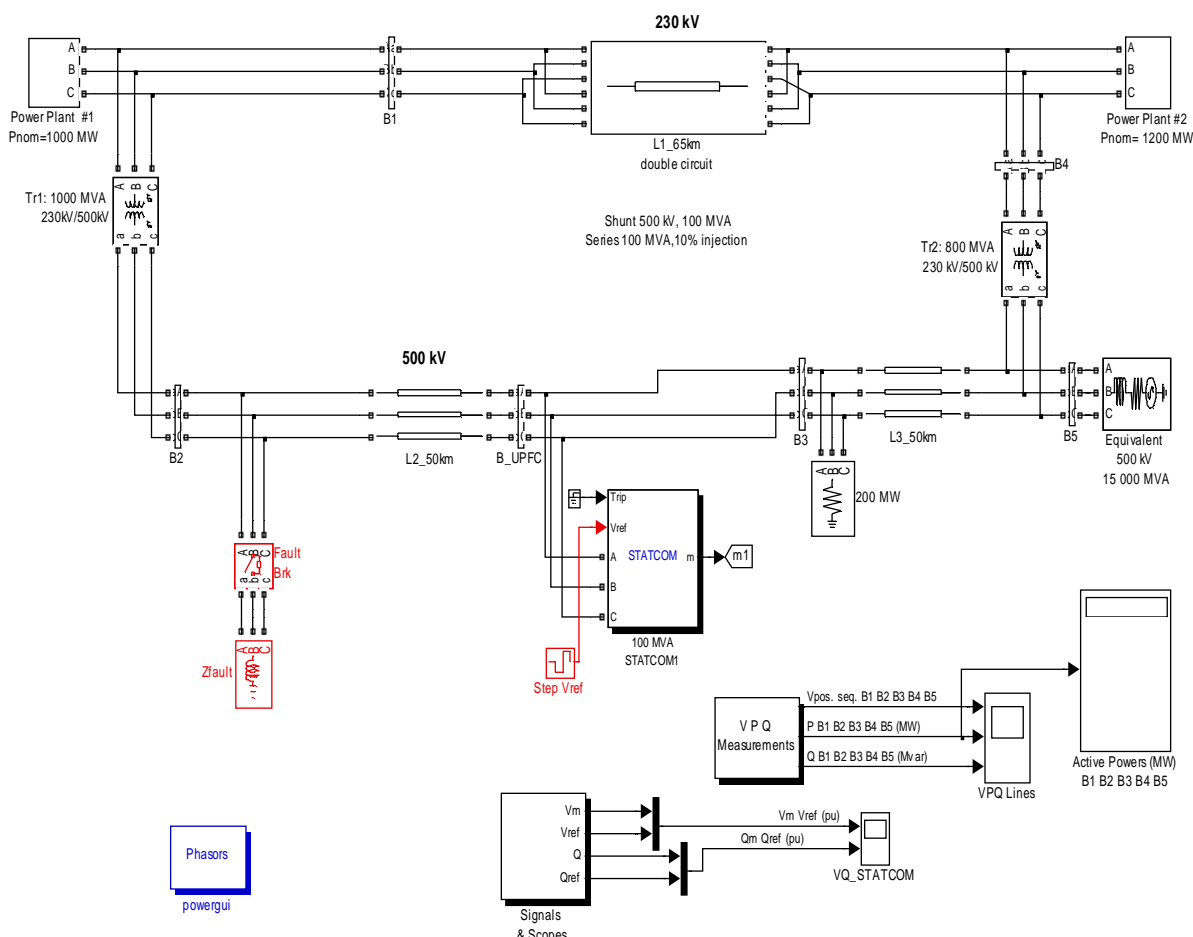

Figure 2 Simulink model of STATCOM

$$P = \frac{V1V2}{X} \sin \delta$$

$$Q = \frac{V1(V1 - V2 \cos \delta)}{X}$$

Where,

V1 = line to line voltage of source V1

V2 = line to line voltage of V2

X = reactance of interconnection transformer and filter

δ = angle of V1 with respect to V2.

In steady state operation, the voltage V2 generated by the VSC is in phase with V1 ($\delta=0$), so that only reactive power is flowing (P=0). If V2 is lower than V1, Q is flowing from V1 to V2 (STATCOM is absorbing reactive power). On the reverse, if V2 is higher than V1, Q is flowing from V2 to V1 (STATCOM is generating reactive power). The amount of reactive power is given by,

$$Q = \frac{V1(V1 - V2)}{X}$$

A capacitor connected on the DC side of the VSC acts as a DC voltage source. In steady state the voltage V2 has to be phase shifted slightly behind V1 in order to compensate for transformer and VSC losses and to keep the capacitor charged.

International Journal of Advanced Research in Electrical, Electronics and Instrumentation Engineering

(An ISO 3297: 2007 Certified Organization)

Vol. 5, Issue 6, June 2016

C. Modelling of UPQC

UPFC is composed of two back to back gate-turn off thyristor (GTO) based, pulse width modulated 6+(PWM) inverters connected by a common DC link. It is assumed that each inverter uses six GTOs with corresponding anti parallel diodes. In order to realize a suitable VA rating for the UPFC in a typical power system application multiple inverters would be required to be coupled in series and/or parallel combinations. The objective is to present the performance of the UPFC using high bandwidth, which can be achieved from correctly paralleling low switching frequency inverters, the inverters can be treated as ideal controllable voltage sources. Therefore the ideal UPFC can be represented in a simple transmission system as shown in Figure 3. In Figure 3 the UPFC is implemented at the receiving end of the transmission line with two bus-bars (V_s and V_r), a transmission line with an inductance L and resistance r . The series inverter (Inverter 2) supplies the compensation voltage V_c while the shunt inverter (Inverter 1) provides the real power demand of Inverter2 and reactive power by controlling V_2 .

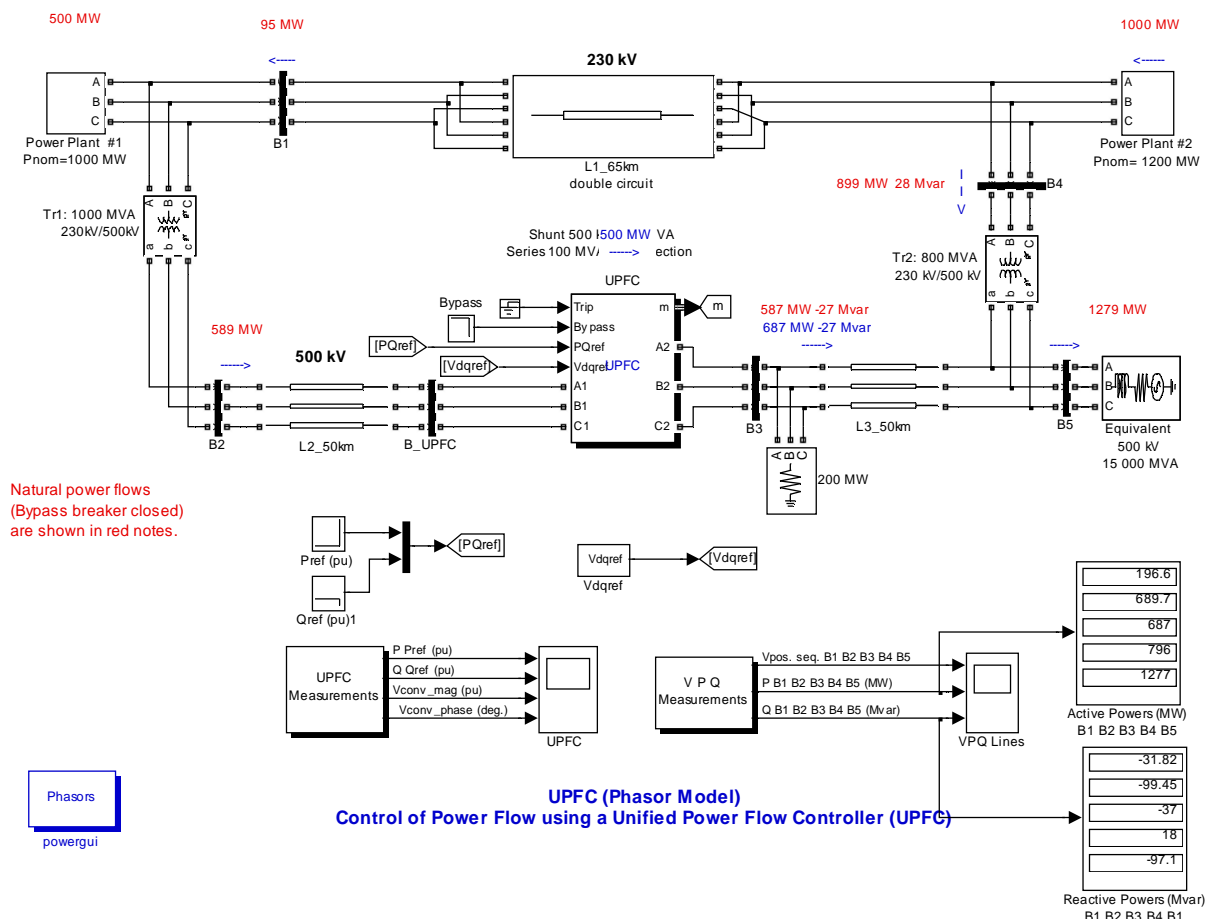

Figure 3 Simulink model of UPQC

IV. SIMULATION AND RESULTS

In this section simulation result of different simulation model of SVC, STATCOM and UPFC is shown. Simulation model consists of a common power system network. In this network each of SVC, STATCOM and UPFC is applied one by one. These FACTS devices are tested in different mode of operation and results are found out.



International Journal of Advanced Research in Electrical, Electronics and Instrumentation Engineering

(An ISO 3297: 2007 Certified Organization)

Vol. 5, Issue 6, June 2016

A. SVC Simulation results

SVC acts basically in Voltage Regulation and VAR control mode. For the selected power system network, result of Voltage Regulation mode has been found out.

In the Figure 4 results of applied reference voltage and measured reference voltage at SVC Bus is shown. Here SVC shows its voltage regulation capability.

B. STACOM Simulation Results

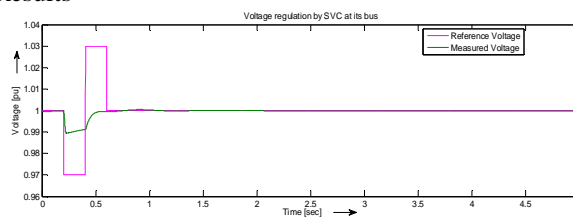

Figure 4 Reference Voltage and measured voltage at SVC Bus.

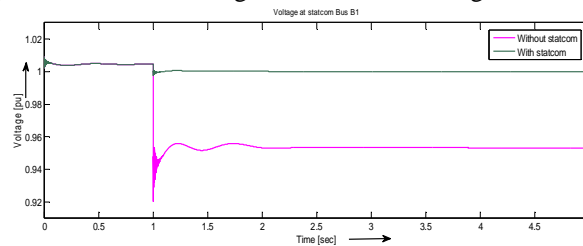

Figure 5 STATCOM connected at Bus B1.

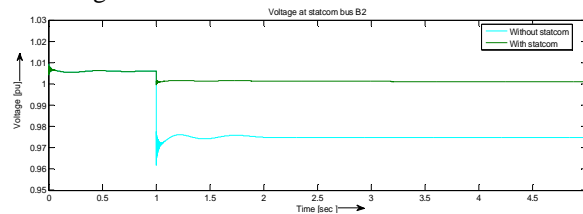

Figure 6 STATCOM connected at Bus B2.

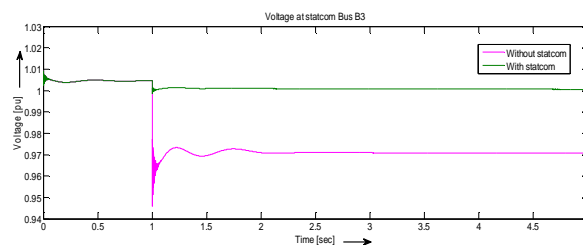

Figure 7 STATCOM connected at Bus B3.



International Journal of Advanced Research in Electrical, Electronics and Instrumentation Engineering

(An ISO 3297: 2007 Certified Organization)

Vol. 5, Issue 6, June 2016

Figure 5-7 shows the voltage waveforms of bus B1, B2 and B3 with perturbation applied at time 1 second.

C. UPQC Simulation Results

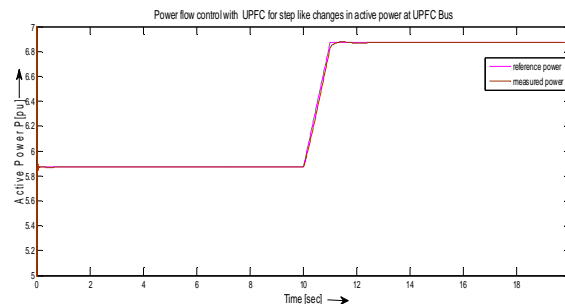

Figure 8 Reference active power with measured active power at UPFC Bus.

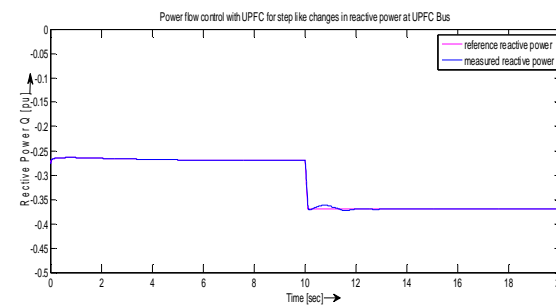

Figure 9 Reference reactive power with measured active power at UPFC Bus

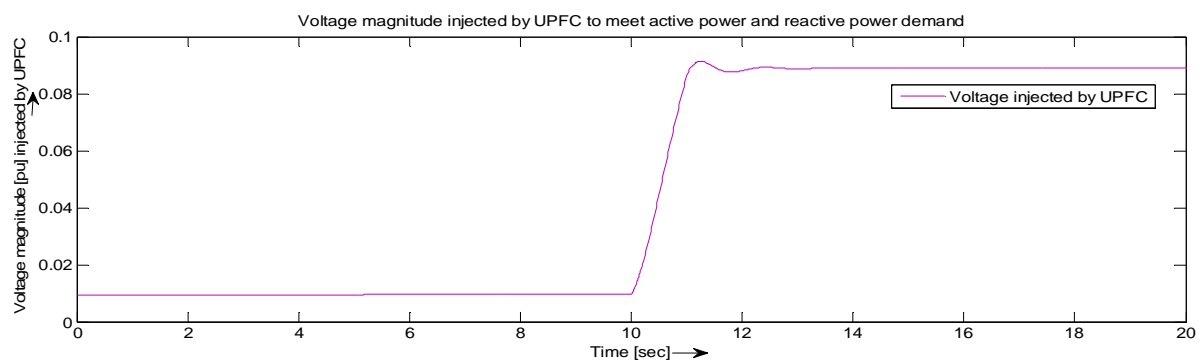

Figure 10 Voltage magnitude injected by UPFC

For the given power system network power flow comparison is being carried out. When UPFC is not connected to the system transformer 2 of 800 MVA capacity is overloaded by 99 MW. UPFC handles this congestion situation and relieves transformer 2 to draw only 796 MW through it. It forces UPFC Bus to draw extra active power through it.



International Journal of Advanced Research in Electrical, Electronics and Instrumentation Engineering

(An ISO 3297: 2007 Certified Organization)

Vol. 5, Issue 6, June 2016

Table I Comparison of active and reactive power flow with and without UPFC

S. No.	UPFC	B ₁ B ₂	B ₂ B ₃	B ₃ B ₅	B ₄ B ₅	B ₄ B ₅ + B ₃ B ₅
1	Not Connected	95.19 MW	588.8 MW	586.8 MW	898.6 MW	1279 MW
		-16.4Mvar	-63.69 Mvar	-26.83 Mvar	26.72 Mvar	-105.6 Mvar
2	Connected	196.6 MW	689.7 MW	687 MW	796 MW	1277 MW
		-31.82 Mvar	-99.45 Mvar	-37 Mvar	18 Mvar	-97.1 Mvar

Thus results in above table of UPFC is showing relieve in congestion between BUS B₄ and BUS B₅ and now transformer2 is not overloaded.

V. CONCLUSIONS

UPFC can control active and reactive power flow in transmission lines. SVC and STATCOM improves system voltage stability. Voltage regulation mode of SVC and STATCOM is successfully simulated in MATLAB. Simulation results are good and they are accepted. UPFC can control active power and reactive power independently. Series compensator of UPFC can be operated in power flow control mode and simultaneously shunt compensator may be operated in voltage regulation or var control mode. Similarly, simulations carried out showed that SVC and STATCOM provides excellent voltage regulation, power factor and active power regulation capabilities.

REFERENCES

- [1] Narain G. Hingurani and Laszlo Gyugyi, "Understanding FACTS technology of Flexible AC Transmission Systems", IEEE Press 2000.
- [2] Y.H. Song, "Flexible ac transmission systems (FACTS)", London: The Institution of Electrical Engineers, 1999.
- [3] Bindeshwar Singh, K.S. Verma, Deependra Singh, C.N. Singh, Archana Singh, Ekta Agrawal, Rahul Dixit, Baljiv Tyagi, "Introduction to FACTS controllers a critical review", International Journal of Reviews in Computing 31st December 2011 Vol. 8, 2011.
- [4] System Operation and control using FACT devices", 17th International Conference on Electricity Distribution Barcelona, 12-15 May 2003.
- [5] M. Arun Bhaskar, C. Subramani, M. Jagdeesh Kumar and Dr.S.S.Dash, "Voltage Profile Improvement Using FACTS Devices: A Comparison between SVC, TCSC and TCPST", International Conference on Advances in Recent Technologies in Communication and Computing 2009.
- [6] Mehrad Ahmadi Kamarposhti, Mostafa Alinezhad, Hamid Lesani and Nemat Talebi, "Comparison of SVC, STATCOM, TCSC, and UPFC Controllers for Static Voltage Stability Evaluated by Continuation Power Flow Method", IEEE Electrical Power & Energy Conference 2008.
- [7] L.Gyugyi, C.D.Schauder, S.L.Williams, T.R.Rietman, D.R. Torgerson and A.Edris, "The Unified Power Flow Controller: A new Approach to Power Transmission Control", IEEE Transaction on Power Delivery, Vol. 10, No. 2, April 1995.
- [8] Zhengyu Huang, Yixin Ni, C.M. Shen, Felix F. Wu, Shousun Chen and Baolin Zhang, "Application of Unified Power Flow Controller in Interconnected Power Systems – Modeling, Interface, Control Strategy, and Case Study. IEEE Transaction on Power Systems, Vol.15, No. 2, May 2000.
- [9] Y. Pannatier, B. KawKabani and J.J. Simod, "Modeling and Transient Simulation of FACTS in Multi-Machine Power Systems", Proceedings of the 2008 International Conference on Electrical Machines, 2008.
- [10] A.J.F. Kesri, A.S.Mehraban, X.Lombard, A.Elriachy and A.A.Edris, "Unified Power Flow Controller (UPFC): Modeling and Analysis, IEEE Transaction on Power Delivery, Vol.14, No. 2, April 1999.
- [11] Papic, P. Zunko, D. Povh and M. Weinhold, "Basic Control of Unified Power Flow Controller", IEEE Transactions on Power Systems, Vol. 12, No. 4, November 1997.
- [12] S D Round, Q Yu, L E Norum and T M Undeland, "Performance of a unified power flow controller using a D-Q control system AC and DC Power Transmission", 29 April-3 May 1996, Conference Publication No.423 copyright IEE, 1996.
- [13] Kumara Deepak, G.Saravana Ilango, C.Nagamani and K. Shanti Swarup, "Performance of UPFC on System Behavior under Fault Conditions", IEEE Indicon 2005 Conference, Chennai, India, 11 - 13 Dec. 2005.
- [14] Rakosh Das Begamudre, "Extra High Voltage AC Transmission Engineering", 1997.
- [15] C. D. Schauder, L. Gyugyi, M. R. Lund, D. M. Hamai, T. R. Rietman, D. R. Torgerson and A. Edris, "operation of the unified power flow controller (UPFC) under practical constraints", IEEE Transactions on Power Delivery, Vol. 13, No. 2, April 1998.
- [16] Kalyan K. Sen, "UPFC - Unified Power Flow Controller: Theory, Modeling, and Applications", IEEE Transactions on Power Delivery, Vol. 13, No. 4, October 1998.
- [17] Yasuo Morioka, Masanao Kato, Minoru Asada, Yasuhiro Mishima, Yoshiki Nakachi and Katsuhisa Tokuhara, "Implementation of Unified Power Flow Controller and Verification for Transmission capability improvement", IEEE Transactions on Power Systems, Vol. 14, No. 2, May 1999.
- [18] Alireza Farhangfar, S. Javad Sajjadi, Saeed Afsharnia, "Power Flow Control and loss minimisation with Unified Power Flow Controller (UPFC)", University of Alberta, May 2004.
- [19] R. Orizondo, and R. Alves, "UPFC Simulation and Control Using the ATP/EMTP and MATLAB/Simulink Programs", Simon Bolivar University, 2006.



ISSN (Print) : 2320 – 3765
ISSN (Online): 2278 – 8875

International Journal of Advanced Research in Electrical, Electronics and Instrumentation Engineering

(An ISO 3297: 2007 Certified Organization)

Vol. 5, Issue 6, June 2016

- [20] J. Faiz, Gh. Shahgholian and M. Torabian, “Design and Simulation of UPFC for Enhancement of Power Quality in Transmission Lines”, International Conference on Power System Technology 2010.
- [21] K.R. Padiyar, A.M. Kulkarni, “Control design and simulation of Unified Power Flow Controller”, IEEE Transactions on the power delivery, Vol. 13, No.4, October 1998.
- [22] S. Tara Kalyani and G. Tulasiram Das, “Simulation of real and reactive power flow Control with UPFC connected to a transmission line”. Journal of Theoretical and Applied Information Technology 2008.