



# **A Hybrid Renewable Energy Distributed Generation System with Vanadium Redox Battery (VRB)**

Vijayakumar.R<sup>1</sup>, M P Mohandass<sup>2</sup>, Rajasindhu.D<sup>3</sup>

Students, Department of Electrical and Electronics Engineering, Kalaingar Karunanidhi Institute of Technology,  
Coimbatore, Tamilnadu, India<sup>1,3</sup>.

Assistant professor, Department of Electrical and Electronics Engineering, Kalaingar Karunanidhi Institute of  
Technology, Coimbatore, Tamilnadu, India<sup>2</sup>.

**ABSTRACT:** Renewable technologies are matured; hybrid renewable energy system is promising to replace conventional fossil fuel distributed power generation. Renewable energy sources are inexhaustible and are renewed by nature itself. Due to ever increasing energy consumption, rising public awareness of environmental protection, and steady progress in power deregulation, alternative (i.e., renewable and fuel cell based) distributed generation (DG) systems have attracted increased interest. Wind and photovoltaic (PV) power generation are two of the most promising renewable energy technologies. Renewable energy sources are inexhaustible and are renewed by nature itself. This paper focuses on a photovoltaic/wind based hybrid power system. This system has three different sources namely solar, wind, and battery power to produce a continuous power supply. The available solar and wind output is boosted to the required level and connected to a common DC bus. The battery for this system is Vanadium Redox flow Battery (VRB). The performance of the energy storage system can be improved by VRB. This paper proposed the hybrid renewable energy system with VRB and the simulation results of VRB. The MPPT is implemented using Perturb and Observe algorithm to obtain the maximum power point. This DC is suitably converted into an AC by a PWM inverter to supply an AC load. In the absence of both wind and the solar output the load is connected through a battery backup source to supply power to the load.

**KEYWORDS:** Hybrid system, Distributed generation, Photovoltaic/Wind, Vanadium Redox flow Battery.

## **I.INTRODUCTION**

Energy is essential to everyone's life no matter when and where they are. This is especially true in this new century, where people keep pursuing higher quality of life. Among different types of energy, electric energy is one of the most important that people need every day. Since natural energy sources are finite and produce pollution, the applications of renewable energy sources in the form of clean technology could be the right solution to solve the energy crisis in the recent century. In order to meet ever increasing demand for conventional energy sources, applications with clean renewable energy technologies such as photovoltaic (PV) energy and wind energy have been vigorously developed in recent years. Hybrid wind-PV system has higher availability to deliver continuous power than either individual source. Distributed generation technologies can provide customers with the energy solutions that are more cost effective, more environments friendly or provide higher power quality or reliability than conventional solutions [1,2]. In our paper a double input and single output power converter is developed for combined Wind-PV power generating systems. And also these circuits have a path for backup energy banks.

Distributed generation (DG) can be defined as a source of small electric power connected to a distribution network or at a customer site, representing an innovative and efficient way to both generate and deliver electricity. Technological developments now allow power generation systems to be built in smaller sizes with high efficiency, low cost, and minimal environmental impact. Distributed generation can serve as a supplement to electricity generated by huge power plants and delivered through the electric grid [10]. Due to natural intermittent properties of wind and solar

# International Journal of Advanced Research in Electrical, Electronics and Instrumentation Engineering

(An ISO 3297: 2007 Certified Organization)

Vol. 3, Issue 10, October 2014

irradiation, standalone wind/PV renewable energy systems normally require energy storage devices or some other generation sources to form a hybrid system. Different renewable energy sources can complement each other, forms hybrid alternative energy systems with proper control have great potential to provide higher quality and more reliable power to customers than a system based on a single resource. There are many combinations of different alternative energy sources and storage devices to build hybrid systems that have been reported in paper [12].

For general purpose and to simplify the analysis, a stand-alone system, including some loads and one renewable hybrid generation unit equipped with a battery bank is considered. For here the battery is used as the VRB. Among rechargeable batteries, the redox flow battery (RFB) has advantageous characteristics in the flexibility of designing ampere-hour capacity and the rapid response. It is appropriate for load levelling and uninterruptible power supply. The RFB system has been widely used in distributed renewable power plants, for example, solar power plants and wind power plants [13-15]. There are currently several types of RFB under development, each employing different redox couples. One of the most popular types is the all-vanadium redox battery (VRB), which has been developed by many institutes and companies [16,17].

This paper is organized as follows: section II present the hybrid system configuration and modeling, it covers all the system configurations and models. Section III presents the control strategy of the hybrid system. Section IV covers the sub system controls. Section V presents the operation of the hybrid system. Section VI simulation results and discussions. Conclusion of the paper is given in section VII.

## II. SYSTEM CONFIGURATION AND MODELING

The modelling of hybrid system and vanadium redox battery is given below,

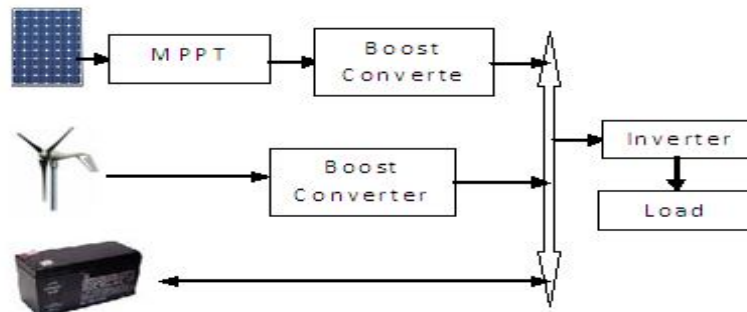

Fig. 1:Block diagram of hybrid system

### A. Solar System Modeling

Solar cell is modelled based on the fundamental relationship between the cell voltage and current output which can be expressed by equation

$$I_{PV} = I_{ph} - I_0 \left[ e^{\frac{qV_{pv}}{kT}} - 1 \right] \quad (1)$$

Where:

$I_{ph}$  = photo current (A)

$I_0$  = Diode reverse saturation current (A)

$q$  = Electron charge =  $1.6 \times 10^{-19}$  (C)

$k$  = Boltzman constant =  $1.38 \times 10^{-23}$  (J/K)

$T$  = Cell temperature (K)

Solar module is modelled by connecting the cells in parallel series to meet real manufacturer specification, which has rating of 300W under standard test condition. Maximum power point tracker is used to extract maximum power from solar array while maintain voltage output at 48V.

# International Journal of Advanced Research in Electrical, Electronics and Instrumentation Engineering

(An ISO 3297: 2007 Certified Organization)

Vol. 3, Issue 10, October 2014

## B. Wind System Modelling

Wind turbine is designed to have low cut in and cut out speed (1.5 m/s – 2.8 m/s) to suit wind condition. The power output equation of wind turbine can be described in equation (2):

$$P_t = \frac{1}{2} \rho \pi C_p V^3 (\lambda, \beta) R^2 \tag{2}$$

Where:  $P_t$  = wind power (W)

$\rho$  = air density ( $\text{kg/m}^3$ )

$V$  = wind speed (m/s)

$R$  = radius of turbine blades ( $\text{m}^2$ )

$C_p$  = wind power coefficient

## C. Battery System Modeling

The electrical equivalent circuit model of the VRB that has been used is shown in Fig. 2. This model to simulate the effect of a VRB for wind/solar hybrid power smoothing application. The parameters of the model are determined assuming that at the operation point where the stack current is maximum and the state-of-charge (SOC) 20% the power losses of the VRB are of 21%. Therefore, at this operation point the overall efficiency is supposed to be 79% [4].

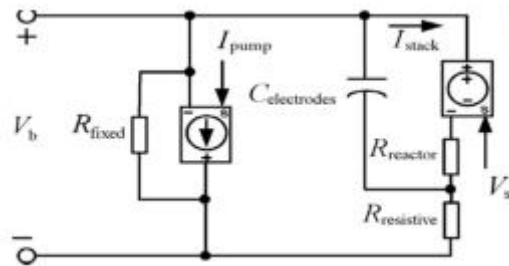

Fig. 2: Equivalent circuit of the VRB

The transient behaviour of the VRB is related to the electrode capacitance as well as to the VRB is related to the electrode capacitance as well as to the concentration depletion close to the electrodes [5]. The proposed model has the following characteristics: (i) the SOC is modelled as a dynamically updated variable; (ii) the stack voltage is modelled as a controlled voltage source, and the power flowing through this source will impact the SOC; (iii) the variable pump loss model, as a controlled current source, is controlled by the pump loss current  $I_{pump}$  that is related to the SOC and the current  $I_{stack}$  flowing through the battery stack [4,5]. VRB power loss includes two parts: (1) one is from the equivalent internal resistances  $R_{reactor}$  and  $R_{resistive}$  and (2) one is parasitic loss due to the parasitic resistance,  $R_{fixed}$  and the pump loss. VRB equivalent circuit parameters are calculated on the basis of the estimated losses for the worst case. When the SOC of 20% is assumed as the worst case, we estimate 15% internal loss and 6% parasitic loss, and resultant total 21% loss [7,8].

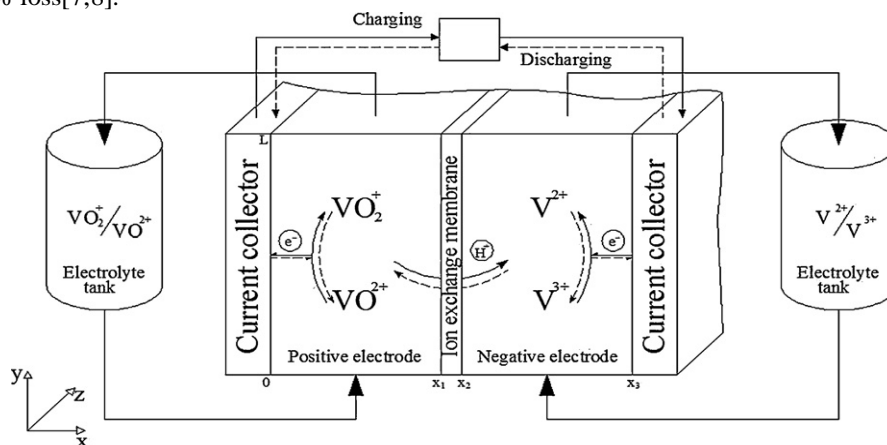

Fig. 3: Schematic diagram of the VRB

# International Journal of Advanced Research in Electrical, Electronics and Instrumentation Engineering

(An ISO 3297: 2007 Certified Organization)

Vol. 3, Issue 10, October 2014

Therefore, the VRB will provide a rated power  $PN$  with 21% loss. If the cell stack's outputPower

$$P_{stack} = PN / (1 - 21\%) \quad (3)$$

A single cell stack voltage  $V_{cell}$  is directly related to the SOC, as follows:

$$V_{cell} = V_{equilibrium} + 2k \cdot \lg(SOC / 1 - SOC) \quad (4)$$

Where  $k$  is a constant related to temperature impact on the battery operation,  $k = 0.059$ ;  $V_{equilibrium}$  is a standard electromotive force difference of each cell [5],  $V_{equilibrium} = 1.25$  V. The parasitic loss, which is related to the pump operation, is separated into fixed and variable losses as follows

$$\begin{aligned} P_{parasitic} &= P_{fixed} + P_{pump} \\ &= P_{fixed} + K(I_{stack}/SOC) \end{aligned} \quad (5)$$

The parasitic resistance  $R_{fixed}$  and the pump loss current are calculated as

$$R_{fixed} = (V_b^2) / (SOC) \quad (6)$$

$$I_{pump} = K(I_{stack} / SOC) / V_b \quad (7)$$

where  $V_b$  is the output terminal voltage of VRB;  $K$  is a constant related to pump loss. The internal resistance loss of 15% can be approximately divided into two parts, i.e., the loss of 9% from  $R_{reactor}$  and the loss of 6% from  $R_{resistive}$ . Each cell has 6 F capacitance, i.e.,  $C_{electrodes} = 6$  F. The single cell voltage is very low, so a high voltage VRB needs a number of cells connected in series [5,6]. The SOC is defined as

$$SOC = (y_{inVRB} / Totalenergycapacity) \quad (8)$$

$$SOC_t = SOC_{t-1} + \Delta SOC \quad (9)$$

$$\begin{aligned} \Delta SOC &= \Delta E / E_N \\ &= (I_{stack} \cdot V_b \cdot \Delta t) / (P_N \cdot T_N) \end{aligned} \quad (10)$$

Where  $SOC_t$  and  $SOC_{t-1}$  are the SOC at the instants of  $t$  and  $t-1$ , respectively;  $\Delta SOC$  is the SOC variation in a time step  $\Delta t$ ;  $T_N$  is the time when total energy  $E_N$  is charged into the battery at a power  $P_N$ .

The equivalent circuit model based simulations are employed to study the charge–discharge characteristics of VRB [4]. The parameters are listed as: rated power  $P_N = 270$  kW, rated capacity  $E_N = 405$  kW h, initial voltage value  $V_N = 810$  V, the cell number  $n = 648$ ,  $R_{reactor} = 0.174 \Omega$ ,  $R_{resistive} = 0.116 \Omega$ ,  $R_{fixed} = 60.5 \Omega$ .

### III. CONTROL STRATEGIES

The overall control scheme is based on the accessibility of renewable energy source. To ensure the load demand is always met, single or up to two sources can be combined to form different modes of operation which can be summarized in table 1. In this system, solar energy subsystem is given preference as main source ahead of wind energy system to supply load.

Table .1: Modes of operation for hybrid system

Modes of Operation	Description
Mode 1 (PV & battery)	Power generated by PV Sub system is more than load demand. Excess power is used for battery charging.
Mode 2 (PV & battery)	Power generated by PV is less than load demand. Battery supplies the remaining power.

# International Journal of Advanced Research in Electrical, Electronics and Instrumentation Engineering

(An ISO 3297: 2007 Certified Organization)

Vol. 3, Issue 10, October 2014

Mode 3 (Wind only)	Power generated by wind Sub system alone is sufficient for load demand.
Mode 4 (Battery only)	PV and wind are inactive, battery is discharged to sufficiently supply load demand.
Mode 5 (Dump Load)	When battery is fully charged, any excess power will be consumed by dump load.

## IV. SUBSYSTEM CONTROL

### A. Maximum Power-Point Tracking (MPPT)

Maximum power point tracking is often called as MPPT. This is an electronic system which commands a solar panel or a set of solar panels to generate the maximum amount of power. The MPPT is not a physical system strapped with solar trackers that position the panels so that they remain under the sun at all times. This fully electronic system varies the electrical operating point of the panels which enables them to deliver the maximum power. The Extra power generated by the panels is made available to the modules in the form of increased battery charging current. MPPT is the automatic adjustment of Electrical Load(s) in order to obtain the utmost power out of the connected solar panels. The output from a solar panel varies every moment due to factors like weather conditions, cloud cover, cell temperature, air mass, module characteristics etc. Solar Irradiance, temperature and total panel resistance have a complex relationship between them. This relationship is expressed by a "curve" called as the I-V Curve. Shown in Fig. 4.

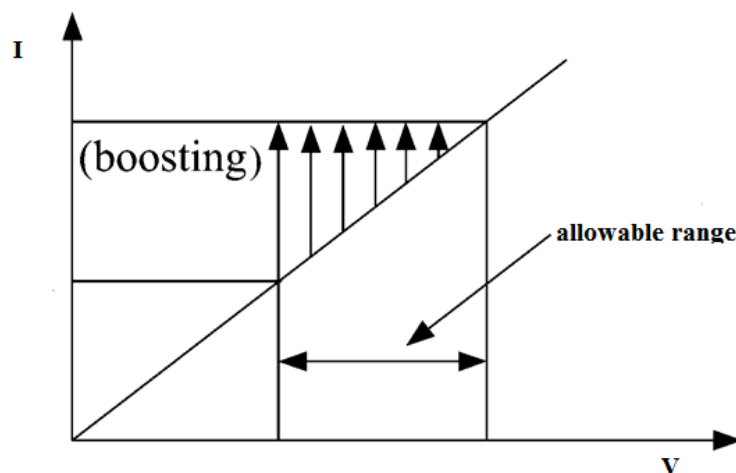

Fig. 4: I-V Characteristics of a solar cell with MPPT

Here "I" is Current and "V" is the Voltage. Any particular PV cell has a single point of operation where the Maximum Power can be obtained but only when the Current (I) and Voltage (V) are the maximum. It can be said that Maximum power is transferred when the connected Load resistance is equivalent to the Series resistance, in our case

# International Journal of Advanced Research in Electrical, Electronics and Instrumentation Engineering

(An ISO 3297: 2007 Certified Organization)

Vol. 3, Issue 10, October 2014

the resistance of the solar cell. You can calculate this using the Maximum Power Transfer Theorem. Now as the Current and Voltage have an exponential relationship the Maximum Power Point (MPP) occurs on the knee of the I-V Curve where

$$\frac{dV}{dt} = 0 \quad (11)$$

It can be said that the Characteristic Resistance of the solar cell is equal to the Load Resistance.

## B. Modes of PV Subsystem Control

As aforementioned, the battery-bank voltage must be taken in account to protect the battery bank against overcharging. According to the battery-bank voltage ( $u_{dc}$ ), we have two modes of operation. Mode 1 is when  $u_{dc} \leq U_{max}$ , and Mode 2 is when  $u_{dc} > U_{max}$ , where  $U_{max}$  is the maximum voltage limit of the battery bank. Illustrates these operating modes. When the voltage  $u_{dc}$  is increased beyond  $U_{max}$ , the relationship ( $u_{dc} = U_{max}$ ) is maintained by decreasing the captured power. The captured power is decreased according to the values of  $\Delta P_g$  and  $\Delta D$ , to move the operating point away from the maximum power point.

## V. OPERATION OF THE HYBRID SYSTEM

This section is devoted to examine the behaviour of the hybrid system. Each of the two subsystems; namely PV subsystem and wind subsystem is controlled by its own controller. In Mode 1, each controller will guide its own system to track the maximum power. In Mode 2, the two controllers are coordinated to follow the maximum voltage constraint. To study Mode 1 of PV subsystem and wind subsystem, state of charge (SOC) of the battery bank is chosen of low value to operate at  $u_{dc} < U_{max}$ .

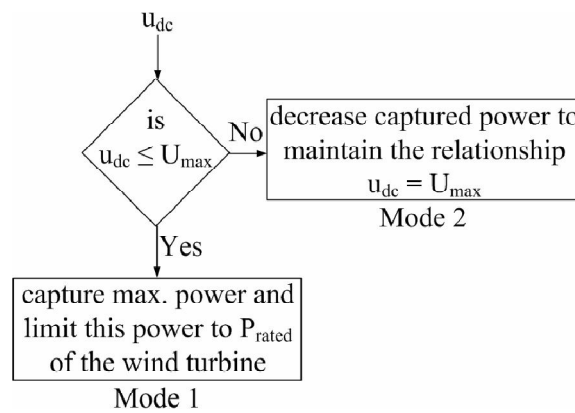

Mode 1  
**Fig. 5: Modes of operation**

## VI. SIMULATION RESULTS AND DISCUSSIONS

The proposed strategy was implemented with the detailed model of the MATLAB Simulink simpower and also with the highly accurate models of the system components. The simulation time step used was 5 micro-seconds to capture the true behavior of the system components. The simulated performance analysis of voltage and current characteristics of Vanadium redox battery is determined in Fig.6(a,b). The vanadium redox battery is charged at the rate of 50%. When the phase angle of the Battery reduces, a part of wind/solar hybrid power is used for charging. When there is reduction in wind power the stored energy from battery is discharged to the load which is controlled by algorithm. The simulated result shows the state of charging and discharging of current and the voltage in p.u. The real power and the reactive power are inferred from the battery, solar, wind turbine and the loads.



# International Journal of Advanced Research in Electrical, Electronics and Instrumentation Engineering

(An ISO 3297: 2007 Certified Organization)

Vol. 3, Issue 10, October 2014

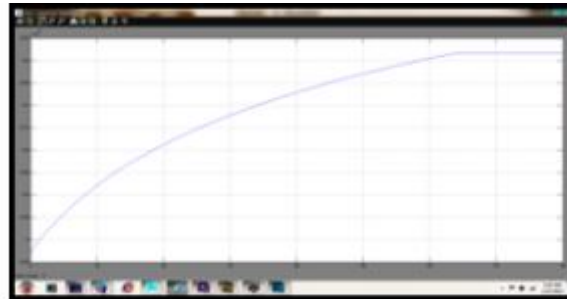

(a)

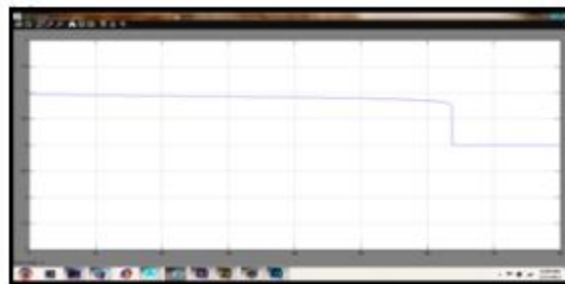

(b)

**Fig. 6:** (a) Voltage of VRB vs time , (b) Current of VRB vs time.

## VII. CONCLUSION

This paper is focused on hybrid power generation and the energy storage system (VRB). The input is from three different sources namely solar power from photo voltaic cell, wind power from wind generator and a battery source (VRB). Battery source acts as effective backup storage. VRB presents many advantages in applications to large scale power energy storage. Its terminal voltage remains stable when the SOC is within 20-80%, to employ only a single stage AC/DC converter in the VRB based Energy storage system to achieve charging and discharging controls, as a result of the simple system structure with high efficiency. A boost converter is used to boost up the input voltage to satisfy the load. This system provides continuous power supply. A common dc bus is responsible for the dc outputs from the sources and act as a single input to the inverter. Further this inverter converts it into ac and given to the respective loads. The performance of the boost converter, inverter has been analyzed and compared with the result obtained from theory and simulation. Many hybrid systems of different topologies are proposed and analyzed in recent years. This project proposes a simple system for continuous power supply with the effective utilization of renewable energy sources. This system can be made as a closed loop for further developments.

## REFERENCES

- [1]. D.B. Chia, B.L. Yong, R.K. Rajkumar, V.K. Ramachandramurthy, "Design of a PV/Wind Hybrid System for Telecommunication Load in Borneo Region" Power Quality Research Group, Dept. of Electrical Power Engineering Universiti Tenaga Nasional (UNITEN) Malaysia, 2012.
- [2]. O. E. M. Youssef, N. M. B. Abdel-Rahim, A. Shaltout, "Performance of Stand-alone Hybrid Wind-Photovoltaic System with Battery Storage" 14th International Middle East Power Systems Conference (MEPCON'10), Cairo University, Egypt, December 19-21, 2010.
- [3]. Monica Alonso, Hortensia Amaris, Carlos Alvarez-Ortega, "Integration of renewable energy sources in smart grids by means of evolutionary optimization algorithms" University Carlos III of Madrid, Electrical Engineering Department, (2012).
- [4]. M. Druga, C. Nichita, G. Barakat and E. Ceanga, "Stand-Alone Wind Power System Operating with a Specific Storage Structure" International Conference on Renewable Energies and Power Quality (ICREPQ'09) Valencia (Spain), 15th to 17th April, 2009
- [5]. S. Arul Daniel and N. AmmasaiGounden, "A Novel Hybrid Isolated Generating System Based on PV Fed Inverter-Assisted Wind-Driven Induction Generators," IEEE Trans. On Energy Conversion, vol. 19, no. 2, June 2004.
- [6]. Fenge Zhang, Quanfu Shi, Yuxin Wang, FengXiang Wang, "Simulation Research on Wind Solar Hybrid Power System Based on Fuzzy-PID Control," Proc. Of Int. Conf. on Electrical Machines and Systems, Oct 8-11, 2007.
- [7]. Integration Limit of Renewable Energy Systems in Small Electrical Grid Gilles Nottona, Ludmil Stoyanovb, Motaz Ezzata, Vladimir Lararob, Said Diaf, Christian Cristofaria.



ISSN (Print) : 2320 – 3765  
ISSN (Online): 2278 – 8875

# International Journal of Advanced Research in Electrical, Electronics and Instrumentation Engineering

*(An ISO 3297: 2007 Certified Organization)*

**Vol. 3, Issue 10, October 2014**

- [8]. D. S. Strebkov, "The Role of Solar Energy in the Power Engineering of the Future", All-Russia Research Institute for Electrification of Agriculture (VNIIESKh), Pervyi Veshnyakovskii pr. 2, Moscow, 109456 Russia, Vol. 53, No. 3. 2006.
- [9]. Emanuel Serban, Helmine Serban, "A Control Strategy for a Distributed Power Generation Micro grid Application with Voltage and Current Controlled Source Converter", IEEE Transactions on, 25(12), 2981-2992, 2010.
- [10]. Thomos Ackermann, Goran Andersson, Lennart Soder, Distributed generation: a definition Elsevier Electric Power Systems Research Vol.57, 2001, pp. 195-204.
- [11]. W. El-Khattan, M.M.A. Salama, Distributed generation technologies, definitions and benefits Elsevier Electric Power Systems Research Vol.71, pp. 119-128, 2004.
- [12]. Modeling and Control of Hybrid Wind/ PV/ Fuel Cell Distributed Generation Systems by Caisheng Wang, MONTANA STATE UNIVERSITY Bozeman, Montana July 2006.
- [13]. C. Ponce de Leon, A. Frias-Ferrer, J. Gonzalez-Garcia, D.A. Szianto, F.C. Walsh, J. Power Sources 160 (2006) 716.
- [14]. Noëlle TASSIN, Storage Technology report: ST 7—Redox Systems, 06/05/2003.
- [15]. Jossen, A., Sauer, D.U. (2006): Advances in Redox Flow batteries. In:
- [16]. First International Renewable Energy Storage Conference (Folien), October 30-31, 2006, Gelsenkirchen,
- [17]. M. Skyllas-Kazacos, R. Robins, US Patent 849,094 (1986).
- [18]. E. Sum, M. Skyllas-Kazacos, J. Power Sources 15 (1985) 179.