



e-ISSN: 2278-8875
p-ISSN: 2320-3765

International Journal of Advanced Research

in Electrical, Electronics and Instrumentation Engineering

Volume 10, Issue 3, March 2021

ISSN INTERNATIONAL
STANDARD
SERIAL
NUMBER
INDIA

Impact Factor: 7.122

9940 572 462

6381 907 438

ijareeie@gmail.com

www.ijareeie.com



Design and Analysis of PI Controller for A Two Tank Non-Interacting Process System

Akil Sanjeev.M¹, Arawinthan.R², Karthikheyen.S³, S.M. Girirajkumar⁴, Aravind P⁵

UG Student, Department of Instrumentation and Control Engineering, Saranathan College of Engineering, Trichy, India¹

UG. Student, Department of Instrumentation and Control Engineering, Saranathan College of Engineering, Trichy, India²

UG Student, Department of Instrumentation and Control Engineering, Saranathan College of Engineering, Trichy, India³

Professor, Department of Instrumentation and Control Engineering, Saranathan College of Engineering, Trichy, India⁴

Asst.Professor, Department of Instrumentation and Control Engineering, Saranathan College of Engineering, Trichy, India³

ABSTRACT: The objective of the work is to maintain the level in the closed loop at desired set value. This paper emphasizes an implementation of internal mode control (IMC) to obtain an optimal PI control setting for non-interacting. System identification of the process is done by process reaction curve method. **The conventional PI controller cannot reach satisfactory result. The gain parameters of PI control are obtained by IMC tuning method.** Initially, a Proportional Integral (PI) controller based on IMC-PI setting is designed and the results are compared with Ziegler Nichols (ZN), Skogestad controller settings. The robustness of the controllers are endorsed by imposing both servo and regulatory disturbances. The simulation results confirm that IMC-PI controller has improved dynamic performance disturbance rejection.

KEYWORDS: PI Control, Non-interacting process, System Identification, Tuning methods, Servo and regulatory disturbances and Performance indices.

I. INTRODUCTION

This industrial control problems are usually non-linear in nature and have multiple control variables. The systems involved in such industrial process show significant uncertainties, non-minimum phase behaviour and a lot of interactions. The two tank system is a benchmark system used to analyse the nonlinear effects in a multivariable process. This helps in realizing the multi loop systems in industries. The part dealt with the level process by the four-tank system where the experimentation done in non-interacting process. The main objective is to enable PI Controller in real time with the suitable controller which provides efficient control action.

II. NON-INTERACTING PROCESS

A physical system can be represented by first order process connected in series the outlet flow from first tank is an inlet flow to second tank. In non-interacting process, the flow of R1 depends only on h1. The variation in h2 in tank 2 does not affect the transient response curve

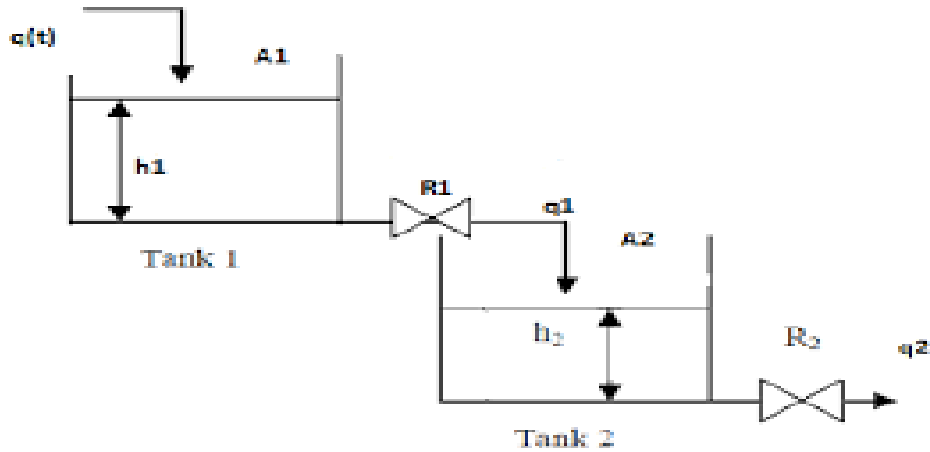

Figure 1 Schematic representation of non-interacting system

The transfer function of tank 1 and tank 2, the general transfer function is

$$\frac{H2(S)}{Q(S)} = \frac{1}{C_1S + 1} \frac{R_2}{C_2S + 1}$$

With the transfer function of non-interacting process, the procedures of system identification and control tuning process is carried out in MATLAB.

III.SYSTEM IDENTIFICATION AND CONTROL TUNING PROCESS

I.SYSTEM IDENTIFICATION

Process Reaction Curve Method:

System identification which is based on the step response. Process identification can be used to build a consistent model, after the process has been positioned in operation. In this method, the small step change is introduced with the help of manual controller. For every input, the transient is recorded which is called process reaction curve. In the graph, a straight line is drawn tangent to the transient curve at the point of inflection. The tangent line intersects the curve in time axis at a point called Transportation lag (τ_d). The apparent time constant (τ) and the steady state gain (k_p) are measured. The representation of s-shaped transient curve

The response of non-interacting system in MULTI VARIABLE TRAINER KIT.

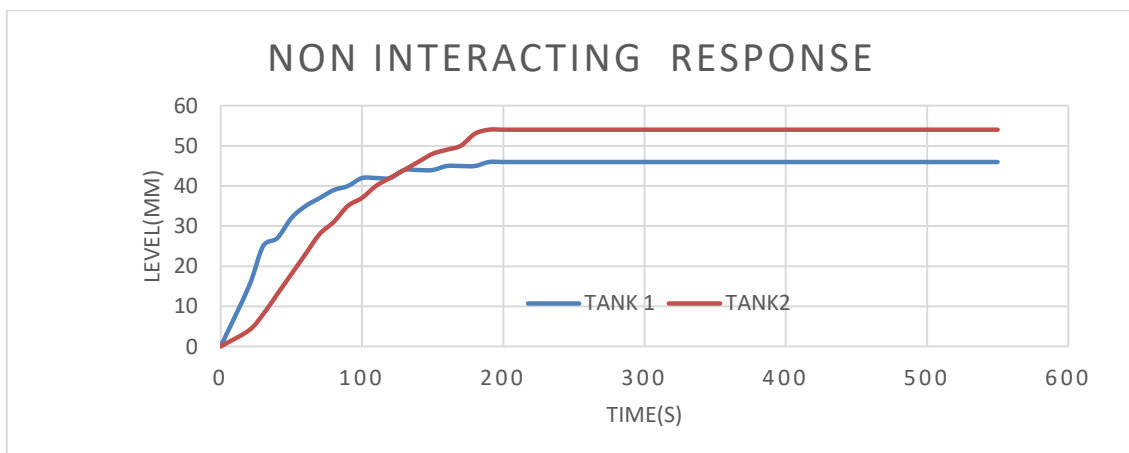

Figure 2. Open loop response of Non -interacting system

The following system identification methods are used to obtain the gain(k), delay time (td), time constant (T), as the result the model validation is obtained. The model is calculated with the real time parameters as

$$G(S) = \frac{1.44e^{-11S}}{1086.75S^2 + 66S + 1}$$



II.CONTROLLER DESIGN

This paper reports the implementation of PI parameters in four design setting. The ZN-PI method, Skogestadmethod and IMC-PI control method. With these techniques, tuning of PI parameters is accomplished to achieve a robust design with the anticipated response time. PI controller is tuned by physically regulating design criteria in two design modes. The response has approximately the similar overshoot as proportional control, but the period is longer; however, the response proceeds to the set point after a comparatively extended settling period. The most advantageous effect of the integral action in the controller is the removal of offset.

A.ZN PI CONTROLLER

The procedures were first suggested by Ziegler and Nichols. They established a closed-loop tuning technique still used today. The method is designated as an open-loop method because the controller remains in the loop as an active controller in automatic mode.

B. IMC-PI CONTROLLER

Internal model control (IMC-PI) is based on a precise model based on the mathematical model of the process. The control system leads to stable and robust. A stable control system is one which keeps suitable control action for the dynamic changes in the control system.

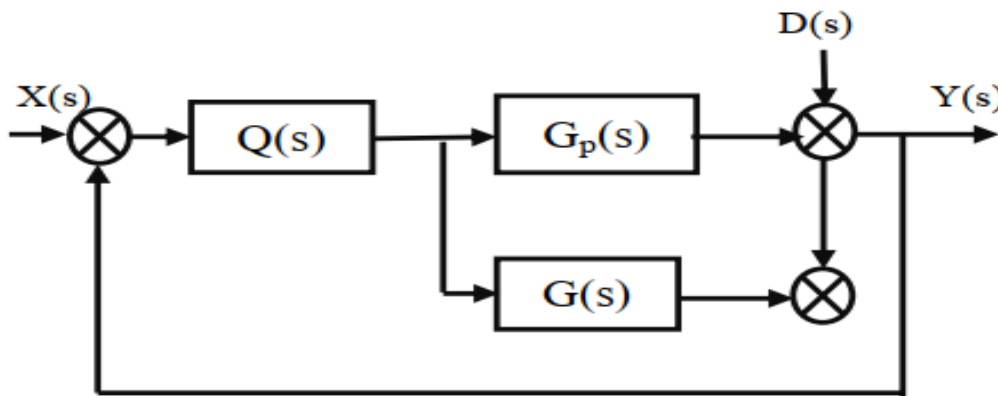

Figure 3. IMC-PI Controller

Here Q(s) is the IMC-PI controller, Gp(s) is the process and G(s) is the model of the process and X(s), Y(s) and D(s) are the set-point, desired output and disturbance respectively.

$$G(S) = \frac{K_p e^{-\tau_d s}}{\tau_s s + 1}$$

Dead time has been calculated by first order pade approximation

$$e^{-\tau_d s} \approx \frac{-0.5s + 1}{0.5s + 1}$$

C.SKOGESTAD -PI CONTROLLER

This method gives PI Controller for different kind of systems. The disturbance compensation is the most important task for the controller, to obtain faster response for the disturbance compensation parameter c is chosen as c=1.5. This value causes larger overshoot in the set point step response and reduces the stability of the control loop. So SKOGESTAD suggested that the closed loop time constant to $\tau_c = \tau$

SKOGESTAD METHOD:

Process Type	Kp	Ti
Time-Constant +delay	$\frac{T}{K(\tau_c + \tau)}$	$\min[T, c(\tau_c + \tau)]$



TABLE 1: CONTROLLER PARAMETERS:

Parameters	ZN	IMC	SKOGESTAD
Kp	1.4809	0.847	0.973
Ki	0.0036	0.0067	0.007769
		75	

SIMULATION RESULTS:

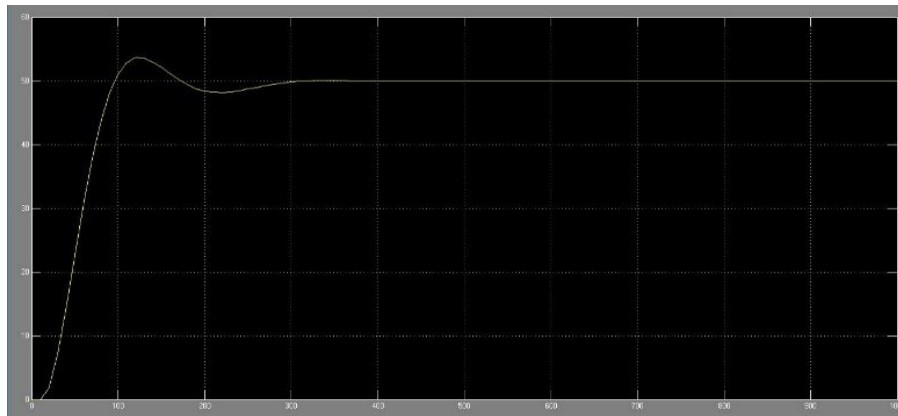

Figure 4 IMC TUNING RESPONSE

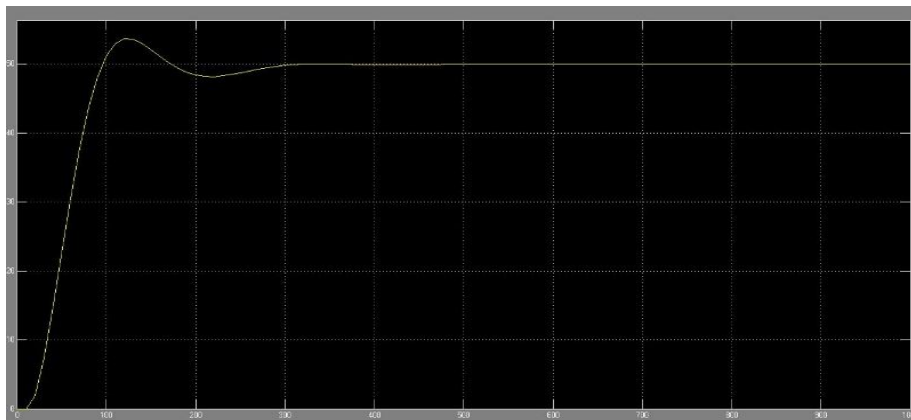

Figure 5 ZN TUNING RESPONSE

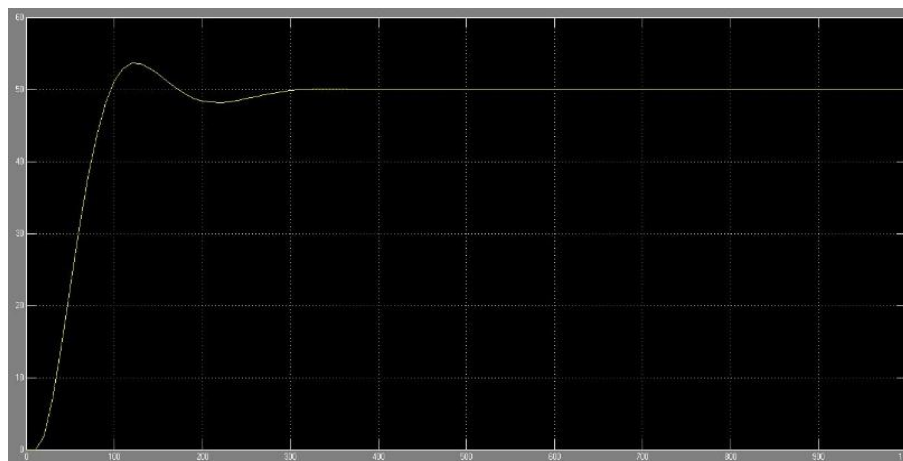

Figure 6 SKOGESTAD TUNINGRESPONSE



COMPARISON OF CONTROLLER PARAMETERS

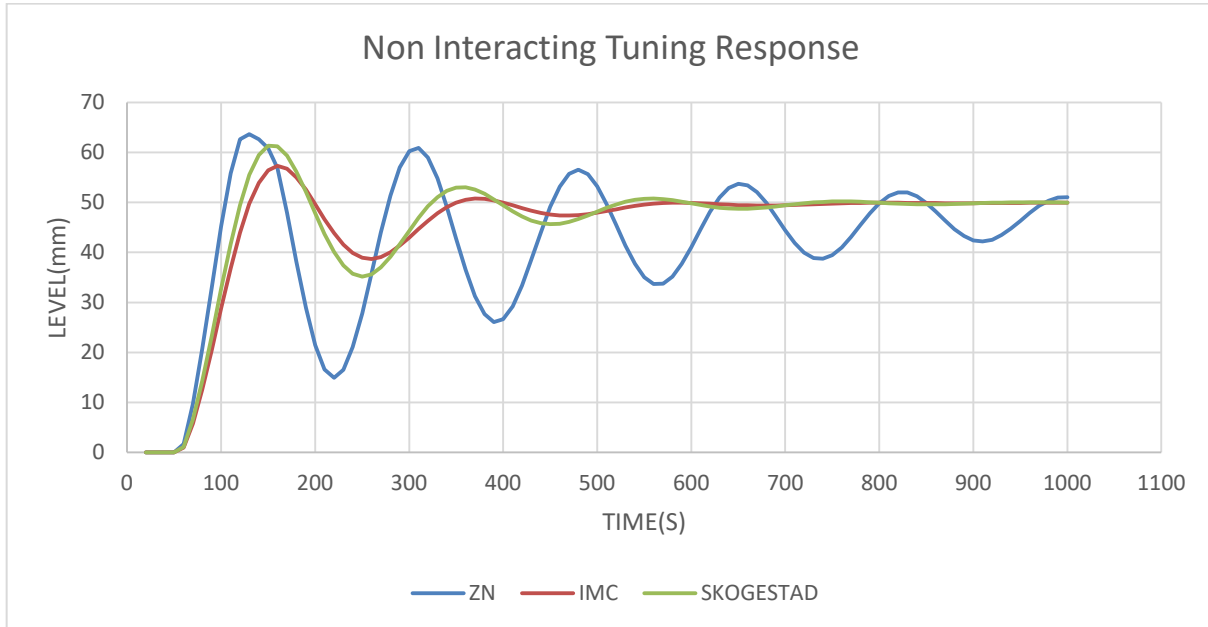

Figure 7 Closed loop tuned responses

IV.RESULT AND COMPARISION

The controller parameters are calculated and applied for set point 50 mm shown in figure. The servo response of the system was witnessed by giving set points of 20 mm, 60 mm and load change response of a process for PI controller is and it evidently states quick response of IMC-PI reacts to disturbance compared to ZN-PI CC-PI and SKOGESTED-PI settings.

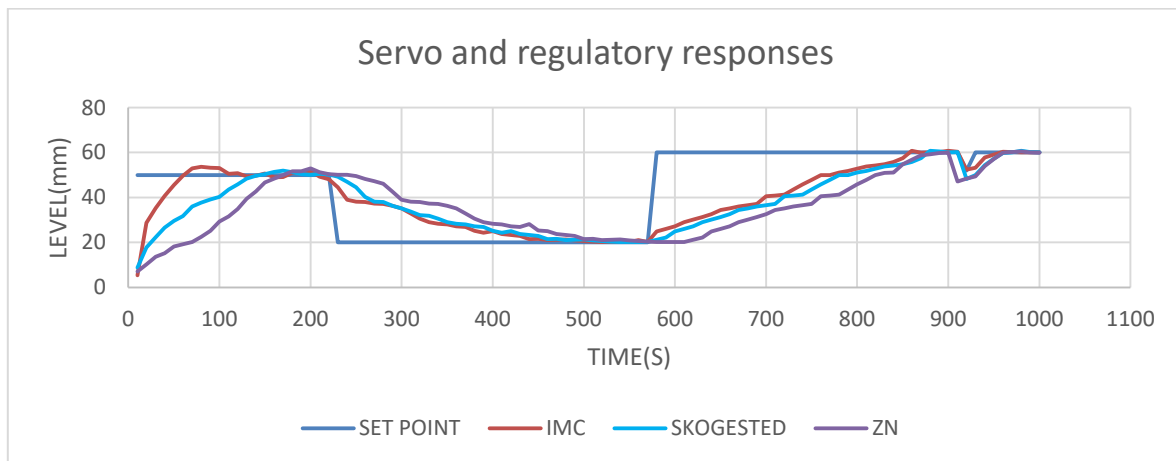

Figure 8 Servo and regulatory responses



COMPARISON OF PERFORMANCE INDICES

METHODS	MSE	ISE	IAE
ZN	1.0502	0.0026	338.3319
IMC	1.0288	0.0029	322.9491
SKOGESTED	1.0332	0.0028	326.2182

V. CONCLUSION

We have proposed an effective method to design the PI controller that can be implemented in real time level process. The result is shown that IMC-PI controller have given good results than ZN-PI and SKOGESTAD-PI controller. From the consequences, the response of IMC was shown satisfactory in terms of ISE, IAE and MSE when compared to the ZN-PI and SKOGESTAD-PI setting. From the response, it is witnessed that the IMC-PI tracks the setpoint with less oscillation when compared to ZN-PI and SKOGESTAD-PI setting. The simulation results has proven that IMC-PI control setting is more effective way in disturbance rejection and to enhance the stability of system.

REFERENCES

- [1] Dinesh Kumar D. and Meenakshipriya, B., "Design and Implementation of Nonlinear System using Gain Scheduled PI Controller," ELSEVIER Procedia Engineering, Vol. 38, 2012
- [2] Ravi, V.R., Thyagarajan, T., Darshini, M. M., "A Multiple Model Adaptive Control Strategy for Model Predictive Controller for Non-interacting Non Linear Systems," Process Automation, Control and Computing (PACC), 2011 International Conference on, Vol., no., pp.1-8, 20-22, 2008.
- [3] D. Dinesh Kumar, C. Dinesh & S. Gautham, "Design and Implementation of Skogestad PID Controller For Non-interacting Spherical Tank System," International Journal of Advanced Electrical and Electronics Engineering, (IJAREEIE). ISSN (Print):2278-8948, Volume-2, Issue-4, 2013.
- [4] M. Lavanya, P.Aravind, M,Valluvan, and Dr. B. Elizabeth Caroline, Model Based Control For Non-interacting And Non-Non-interacting Level Process Using Lab view, International Journal of Advanced Research in Electrical, Electronics and Instrumentation Engineering, Vol 2, Issue 7, July 2013
- [5] B. Wayne Bequette, Process Control Modeling, Design and simulation, Prentice-Hall of India, 2004
- [6] K. J. Astrom, "Automatic tuning of PID regulators," Instrument Society of America, 1988.
- [7] J. G. Ziegler and N. B. Nichols, "Optimum settings for automatic controllers," Transactions of American Society of Mechanical Engineers, Vol. 64, pp. 759-768, 1942.
- [8] M. Morari and E. Zafiriou, Robust process control, Englewood Cliffs, Prentice-Hall, NJ, 1989.
- [9] D. R. Coughanowar, Process Systems Analysis and Control, Tata McGraw Hill, 1991.
- [10] P Aravind, M Valluvan, B Sangeetha, Model Based Controller Design for Level Process, International Journal for Computer Applications, Vol.88- No.18, 2014.
- [11] W. B. Bequette, Process Control Modeling and Simulation, Prentice Hall, 2003.
- [12] P Aravind and M Valluvan, PSO Based Optimization of a PID Controller for a Linear Tank Level Control Process, International Journal of Current Engineering and Technology, Vol-4, No.2, pp.

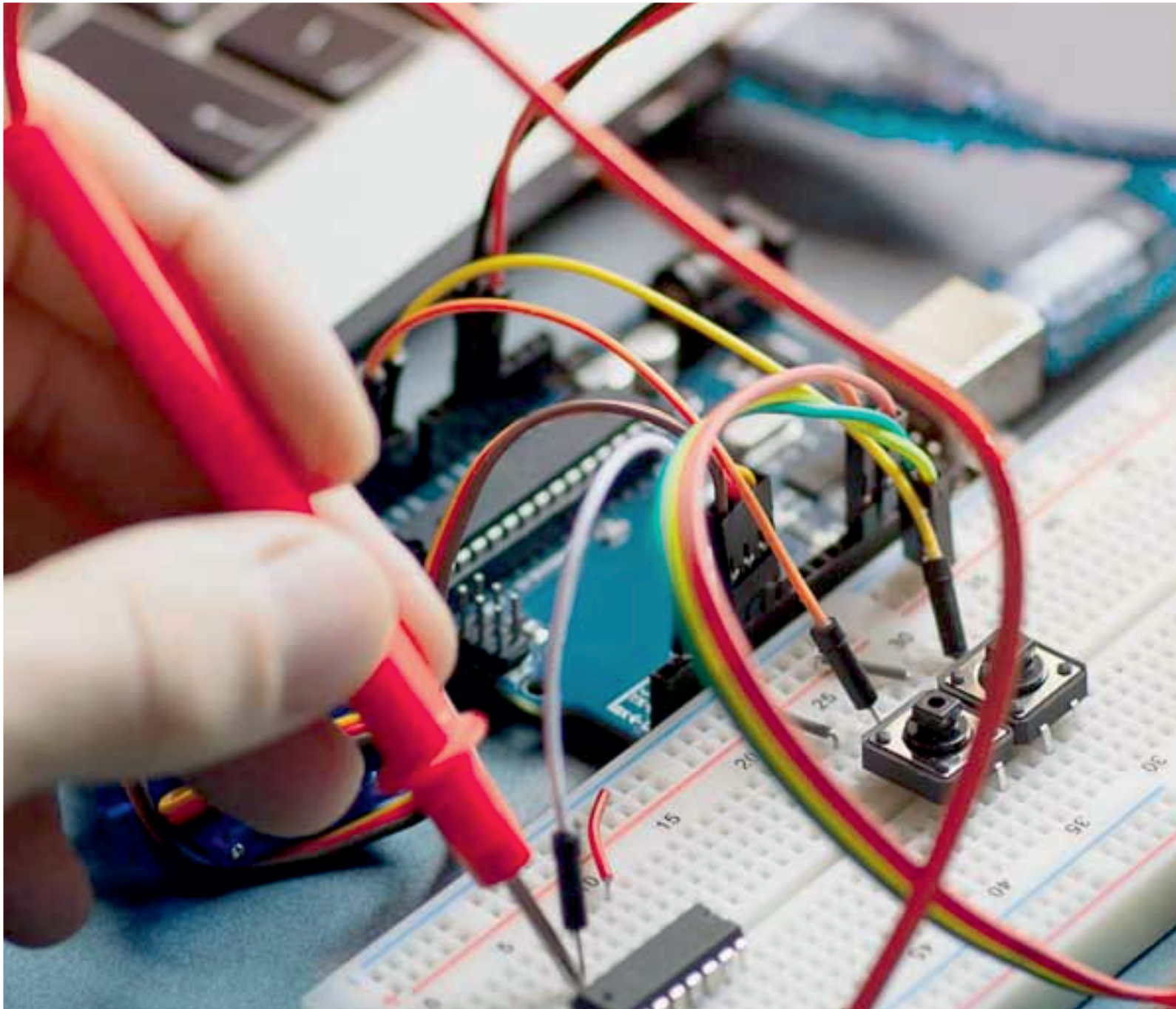

INNO  **SPACE**
SJIF Scientific Journal Impact Factor

Impact Factor:
7.122

ISSN INTERNATIONAL
STANDARD
SERIAL
NUMBER
INDIA



International Journal of Advanced Research

in Electrical, Electronics and Instrumentation Engineering

 **9940 572 462**  **6381 907 438**  **ijareeie@gmail.com**



www.ijareeie.com

Scan to save the contact details