



A Smart Waste Management and Monitoring System Using Automatic Unloading Robot

Nithya.L¹, Mahesh.M²

P.G. student, Communication Systems (ECE), Idhaya Engineering College for Women, Chinnasalem, Tamilnadu, India¹

Assistant Professor, Department of Electronics and Communication Engineering, Idhaya Engineering College for Women, Chinnasalem, Tamilnadu, India²

ABSTRACT: In our city, dustbins placed at public places are overflowing. It creates unhygienic conditions for the people. Also it creates ugliness to that place. At the same time bad smell is also spread. Nowadays, there are number of techniques which are purposefully used are being build up for well management of garbage or solid waste. We are going to implement a project called A Smart Waste Management and Monitoring System with automatic Unloading Robot to avoid situations of this type. To give a brief description, at the public places, the sensors are placed in the common garbage bins. When the garbage reaches the level of the sensor, then that indication will be given to PIC microcontroller. Robot used to collect the wastes after reaching high wastage level. To move the robot from garbage area and unload the wastage by Using DC Motor. The waste filling level and air pollution level is sent as message through GSM modem interface to the microcontroller. The outcome of this method is efficient and intelligent and can be used to automate any solid waste bin management process.

KEYWORDS: PIC microcontroller, Robot, Dc Motor, waste management, GSM modem.

I. INTRODUCTION

The process of making things automatic is being exploited in almost all the major fields of life. Making things automatic reduces burden on the humans. The cost and effort used in manually controlled products is much higher than the automated systems. Considering the fact, that the problem of efficient waste management is one of the major problems of the modern times, there is an utmost need to address this problem. The proper waste management system is must for the hygienic society in general and for world as a whole. Solid waste which is one of the sources and causes of environmental pollution has been defined under Resource Conservation and Recovery Act as any solid, semi-solid liquid or contained gaseous materials discarded from industrial, commercial, mining or agricultural operations and from community activities. Solid waste also includes garbage, construction debris, commercial refuse, and sludge from water or waste treatment plants or air pollution, control facilities and other discarded materials. In order to protect human health and the environment from the potential hazards of delayed waste disposal and environmental pollution a systematically supervised and controlled handling of these wastes is must. The type of wastes which constitute environmental pollution and which this work emphasizes on is domestic refuse consisting of degradable food wastes, leaves, dead animals and non-degradable ones such as plastics, bottles, nylon, medical and hospital wastes, generated in households, hospitals, industries and commercial centres.

EXISTING SYSTEM

Intelligent solid waste bin is essential to develop an efficient and dynamic waste management system. This research presents the implementation and execution of an integrated sensing system and algorithm for solid waste bin to automate the solid waste management process. Several sensing methods have been integrated and have combined their verdicts that offer the detection of bin condition and its parameter measurement. A number of test runs have been conducted to assess the functioning of the prototype system. The outcome showed that the sensing system with the

International Journal of Advanced Research in Electrical, Electronics and Instrumentation Engineering

(An ISO 3297: 2007 Certified Organization)

Website: www.ijareeie.com

Vol. 6, Issue 3, March 2017

algorithm is efficient and intelligent and can be simply used to automate any solid waste bin management process.

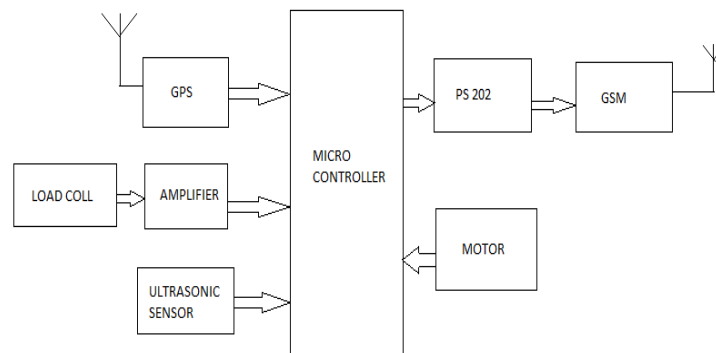

Fig 1.1 Block Diagram of Existing System

II. RELATED WORK

A. Decision Support System for Solid Waste Site Allocation Using GIS

One of the most sensitive and emerging problem to every Municipality in the world is of solid waste management. Solid waste is daily outcome of human activities, which can never stop. There are various sources of solid waste which generates large and diverse nature of waste in urban cities. The main reason of increase in solid waste in urban cities is the fast increase in urban population. Nanded is one of the urban cities in Maharashtra of country India. Nanded Waghala City Municipal Corporation (NWCMC) facing the solid waste management problems as there is lot increase in population. NWCMC has not any scientifically chosen solid waste site. Unscientific waste management causes urban cities to face environmental, health and socioeconomic problems. The most common solution to solid waste management is to find a scientifically solid waste site or dumping site to city. Finding scientific and suitable solid waste site is very complicated task as it requires huge amount of spatial data to be stored, managed, evaluated and analyzed. The new technology, Geographic Information System, which is capable to store, manipulate and retrieve huge amount of spatial data along with Multi Criteria Decision Making method was able to solve efficiently such solid waste problems with less efforts and by saving money and time.

B. Development of Decision Support System for Municipal Solid Waste Management In India

The Complexity of Issues Involved in municipal solid waste management necessitates development and application of new tools capable of processing data inputs of varying formats, numerical models and expert opinions in multi objective decision making scenario. Decision Support Systems (DSS) are among the most promising approaches to confront such situations. After adoption of Municipal Solid Waste (Management and Handling) Rules, 2000 in India, the necessity of development of an environmental decision support system (EDSS) has further increased. Most DSS for solid waste management (SWM) constructed in the past deal with one or a few components of the whole process. This segmented approach does not provide a complete view of the interactions and effects of all functional elements in the whole complex system. In constructing the DSS, various elements must be integrated and optimized as per the required regulative, technical and social framework to produce a viable model that has practical applications. The DSS models should ideally be integrated with geographical information system (GIS) to optimize collection, transportation, processing and disposal processes. This paper attempts to present an overview of DSS in the area of solid waste management with specific reference to their development and applications in India. There appears a definite need for development of a comprehensive and user friendly EDSS for solid waste management in Indian regulative and social set up. A conceptual frame work for one such proposed decision support system, named 'EDSSMSWI' has been discussed.



International Journal of Advanced Research in Electrical, Electronics and Instrumentation Engineering

(An ISO 3297: 2007 Certified Organization)

Website: www.ijareeie.com

Vol. 6, Issue 3, March 2017

C. Smartphone Inertial Sensor Based Indoor Localization and Tracking With Ibeacon Corrections

Global Positioning system (GPS) can be readily used for outdoor localization but GPS signals are degraded in indoor environments. How to develop a robust and accurate indoor localization system is an emergent task. In this paper, we propose a smartphone inertial sensor based indoor localization and tracking system with occasional iBeacon corrections. Some important issues in smartphone based pedestrian dead reckoning (PDR) approach, i.e. step detection, walking direction estimation and initial point estimation are studied. One problem of the PDR approach is the drift with walking distance. We apply a recent technology, iBeacon, to occasionally calibrate the drift of the PDR approach. By analyzing iBeacon measurements, we define an efficient calibration range where an extended Kalman filter is utilized. The proposed localization and tracking system can be implemented in resource-limited smartphones. To evaluate the performance of the proposed approach, real experiments under two different environments have been conducted. The experimental results demonstrated the effectiveness of the proposed approach. We also tested the localization accuracy with respect to the number of iBeacons.

D. Smartphone-Based Human Fall Detection System

The use of technology has proven to be a value asset in the health department. Nowadays, from computers to smart phones, technology helps people in their activities being these personally or cooperatively. Thanks to these advantages, new research has develop to create systems and applications to help with people's health, in our case detecting fall accidents with the use of smart phones. This paper presents an approach to detect falls using different proposed algorithms with the goal of helping people with their health and security. The system is composed of three different components: data collection, location selection, and fall detection. It utilizes the Smartphone's built-in sensors (accelerometer, gyroscope) to identify the location of the smart phone in the user's body (chest, pocket, holster, etc.) and once a location is identifies, the fall detection component takes place. A general description on fall detection systems is provided, including the different types of sensors used nowadays. The proposed solution is presented and described in great detail. A total accuracy of 81.3% was calculated from the fall detection proposed algorithm. The top three locations to detect a fall were: texting with 95.8% fall detection accuracy, pants' side pocket with an 87.5% accuracy, and shirt chest pocket with 83.3% accuracy. Also an extra study was done using only the holster location generating an excellent 100% location selection accuracy.

E. GIS Based Approach for Site Selection In Waste Management

Strategic models identify areas of development opportunity and constraints for long term management strategies. A GIS based environmental decision support system for solid waste management under Indian socio-economic and regulatory conditions has been developed. For selection for primary landfill site selection using analytical hierarchy process (AHP) has been used to give weights to different criteria. The criteria were aggregated and suitability index (S) is generated using weighted linear combination (WLC) technique in GIS environment. The suitability index (0-10) values are classified into four categories (Excluded, Less Preferable, Suitable and Best Suitable) to select the landfill state.

III. PROPOSED METHODOLOGY

Now days, there are a number of techniques which are purposefully used and are being build up for well management of garbage or solid waste.

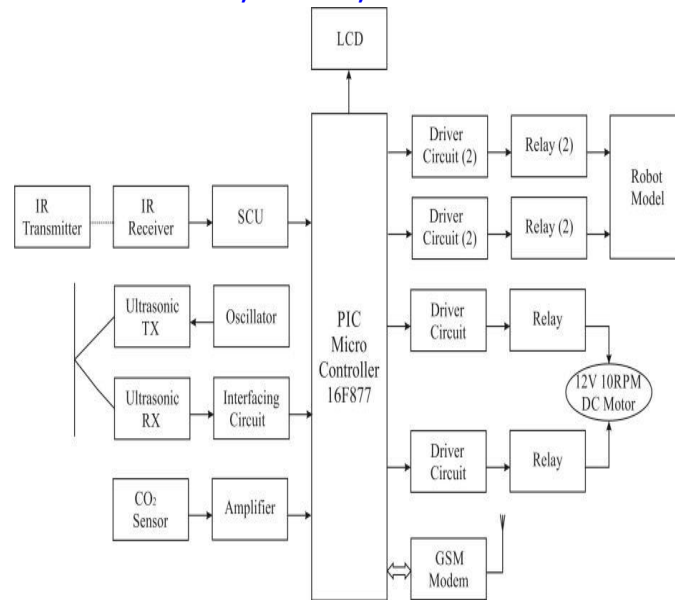

*With Robot model & 12V 10RPM DC Motor.

Fig 3.1 Block Diagram of Proposed System

The Hardware components which include,

- . PIC Microcontroller
- . LCD Display
- . IR Sensor
- . Ultrasonic Sensor
- . Air Pollution Sensor
- . GSM Modem
- . Driver Circuit
- . Relay
- . Robot Model
- . Dc Motor

To give a brief description of the project, the sensors are placed in the common garbage bins placed at the public places. When the garbage reaches the level of the sensor, then that indication will be given to PIC microcontroller. Robot used to collect the Wastage level is high to move the robot in garbage area and unload the wastage using DC motor.

The complexity of issues involved in municipal solid waste management necessitates development and application of new tools capable of processing data inputs of varying formats, numerical models and expert opinions in multi objective decision making scenario. Decision Support Systems are among the most promising approaches to confront such situations. The DSS models should ideally be integrated with geographical information system to optimize collection, transportation, processing and disposal processes. An attempt to present an overview of DSS in the area of solid waste management with specific reference to their development and applications in India.

International Journal of Advanced Research in Electrical, Electronics and Instrumentation Engineering

(An ISO 3297: 2007 Certified Organization)

Website: www.ijareeie.com

Vol. 6, Issue 3, March 2017

IV. RESULTS AND DISCUSSION

A. Overall Hardware Kit

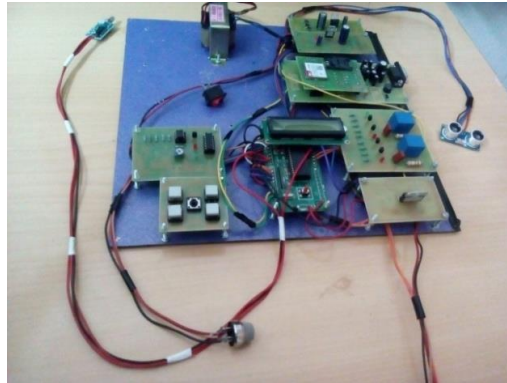

Fig 4(a) shows the overall hardware kit which includes some components like Ultrasonic Sensor, Air Pollution Sensor, IR Sensor, PIC micro controller and GSM modem used for this project.

B. Ultrasonic Sensor Output



Fig 4(b) shows ultrasonic output when it reaches the maximum level of the sensor.

Ultrasonic Sensor Output from Gsm Modem To Mobile

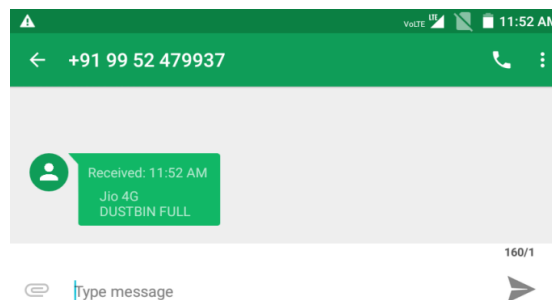

Fig 4(c) shows the message sent from GSM modem when ultrasonic sensor senses the dustbin is full.

C. Air Pollution Sensor Output

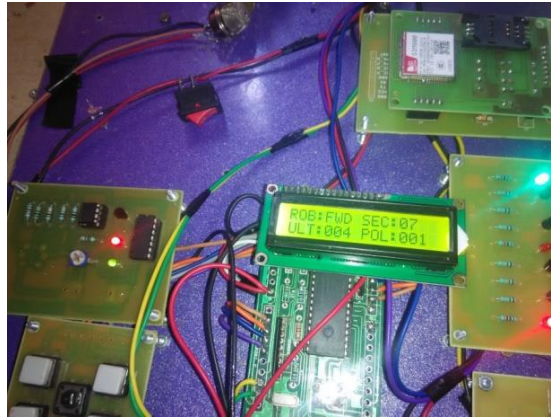

Fig 4(d) shows Air Pollution sensor output when the sensor sensing carbon dioxide gas inside bin.

Air Pollution Sensor Output from GSM Modem to Mobile

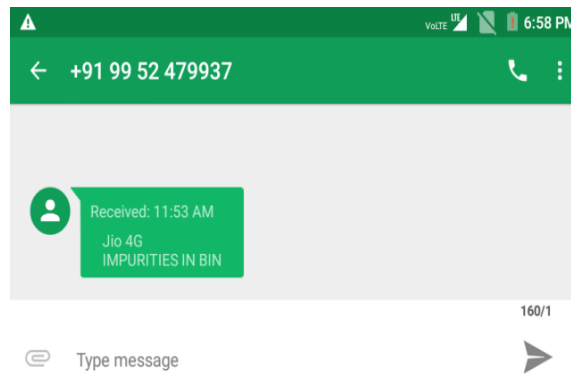

Fig 4(e) shows message sent from GSM modem when Air pollution sensor senses some harmful gases inside bin.

D. IR Sensor Output in Absence of Object

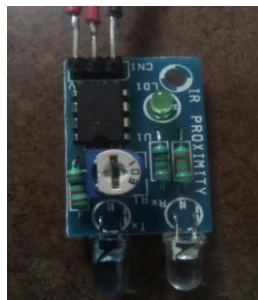

Fig 4(f) shows IR output in absence of object.



International Journal of Advanced Research in Electrical, Electronics and Instrumentation Engineering

(An ISO 3297: 2007 Certified Organization)

Website: www.ijareeie.com

Vol. 6, Issue 3, March 2017

Presence of Object



Fig 5(g) shows the IR Sensor output in presence of object before the sensor transmitter and receiver in which LED blinks when the sensor which detects the presence of obstacles in the moving path.

V. CONCLUSION

A Smart waste management system is a step forward to make the manual collection and detection of wastes automated in nature. The developed system integrated by using the smart Vehicle System and the Smart Monitoring and controlling, in which it would pioneer work for solid waste collection, monitoring and management processes. The currently employing method in which concerned municipal employee has to look for the filled waste bins manually across different spots in an area/street for checking regularly whether the waste bin is filled or not, which is complex and time consuming process. This automation of waste also reduces the human effort and consequently the cost of the whole process. Robot model is used for carrying and unloading the solid wastes in dustbin by using DC motor. This Method is most effective in large corporation areas. This method can be implemented practically. In future, some additional features will add to this project to crush and recycling plastics and other materials automatically.

REFERENCES

- [1]. Adil Bashir, Shoaib Amin Banday, Ab. Rouf Khan, Mohammad Shafi, "Concept, Design and Implementation of Automatic Waste Management System", International Journal on Recent and Innovation Trends in Computing and Communication ISSN 2321 – 8169 Volume: 1 Issue: 7 604 – 609.
- [2]. Meena Deswal and J.S Laura(2014) "Application of GIS in MSW management in India", International Journal of Engineering Research and Development e-ISSN: 2278-067X, Volume 10, Issue 1, PP.24-32.
- [3].Mmr.. Jjaaypppraakkaasshh RR. Dduuvvee11,, Ddrr.. Nniilleesshh KK.. Ddeesshhmmuukkhh22,, Ddrr.. Pprraakkaasshh RR.. Kkoolllhee3(2015), "Decision Support System For Solid Waste Sites Allocation Using GIS", International Journal Of Computer Application (2250-1797) Volume 5– No. 5.
- [4]. Ohri.A, Singh.P.K(2010), " Development of Decision Support System for Municipal Solid Waste Management in India" International Journal Of Environmental Sciences Volume 1, No 4.
- [5]. Simon Mayer, Ruben Verborgh, Matthias Kovatsch, And Friedemann Mattern, "Smart Configuration Of Smart Environments", IEEE Transactions On Automation Science And Engineering.
- [6]. Surendra Kumar Yadav(2013), "GIS Based Approach For Site Selection In Waste Management", International Journal Of Environmental Engineering And Management, ISSN 2231-1319, Volume 4, Number 5, Pp. 507-514.
- [7]. Valcourt, Y. D. L. Hoz, And M. Labrador(2016), "Smartphone-Based Human Fall Detection System", IEEE Latin America Transactions, Vol. 14, No. 2.
- [8]. Zhenghua Chen, Qingchang Zhu, and Yeng Chai Soh, "Smartphone Inertial Sensor Based Indoor Localization and Tracking with iBeacon Corrections", IEEE Transactions on Industrial Informatics.