



International Journal of Advanced Research in Electrical, Electronics and Instrumentation Engineering

(An ISO 3297: 2007 Certified Organization)

Vol. 3, Issue 6, June 2014

On The Broadbanding Characteristics of Multiresonant E Shaped Patch Antenna

Sarma SVRAN¹, Vamsi Siva Nag Ch², K.Naveen Babu³, Chakravarthy VVSS³

Dept. of BS & H, Vignan Institute of Information Technology, Visakhapatnam, AP, India¹

Dept. of ECE, SITAM, Vizianagaram, AP, India²

Dept. of ECE, Raghu Institute of Technology, Visakhapatnam, AP, India³

ABSTRACT: The idea of punching slots on patch antenna to achieve multi-resonant and further broadbanding characteristics has been intelligent technique. One such geometry is E shaped antenna in which two parallel slots are tweaked out at one side symmetrically to form an E shaped antenna, which is adopted in this paper to study its broadband characteristics. Besides geometrical variations two others techniques like increasing the substrate height and decreasing the dielectric constant of the substrate are also incorporated with a limitation for fabrication ease. The resultant antenna has shown a broad band characteristics of nearly 3.71 GHz.

KEYWORDS: Broadbanding, patch antenna, E shaped, slot antenna.

I. INTRODUCTION

A patch antenna is simple in structure occupies low volume and conformal to the region of installation there by leading to miniaturization of the electronic gadget in which it has to be embedded. The patch can also be fabricated with ease of bulk fabrication as well as with low cost. Besides these the patch antennas have a disadvantage of narrow bandwidth which constraints the operation to few applications. In general some communication systems demand for operation at multiple frequencies which are closely spaced. In such cases utilization of multiple antennas for multiple frequencies of operation would make the communication system more bulky. In such cases a single antenna with wide band characteristics covering all the bands of frequencies would be helpful. As discussed a patch antenna by basic nature narrow banded. Hence exploring several broadbanding techniques have become good part of research in antennas.

In this paper an E shaped microstrip patch antenna is used to obtain a wide bandwidth characteristics. The antenna is designed and simulated in High Frequency Structure Simulation (HFSS) Tool which has the capability of solving the electromagnetic structures using Finite Element Method. The designed antenna is solved and various reports like reflection coefficient, VSWR, Radiation Pattern and Directivity are taken.

II. BROADBANDING AND THEIR LIMITATIONS

The bandwidth of patch antenna can be increased by the height of the substrate or by decreasing the value of the dielectric constant of substrate.

Bandwidth of patches can be given by the expression-

$$BW = s - 1 / Q * s^{1/2}$$

For $s=2$, & substituting for Q in terms of energy stored & power radiated we can write

$$BW = \sqrt{2hG_e / \pi c \sqrt{\epsilon_r \epsilon_0} b_e} \dots \dots \dots (a)$$

Where G_e is the edge conductance, b_e is the effective width, h is the substrate thickness ϵ_r is the effective dielectric constant.

Based on the above characteristic equations we can deduce the following points.

- 1- Decreasing the Q factor of patch by increasing substrate height & decreasing the dielectric constant.
- 2- Use the multiple resonator located in one plane.
- 3- Electromagnetically coupled patch Antenna.
- 4- Use of multilayer configuration with multilayer resonators stacked vertically.

International Journal of Advanced Research in Electrical, Electronics and Instrumentation Engineering

(An ISO 3297: 2007 Certified Organization)

Vol. 3, Issue 6, June 2014

The bandwidth of the micro strip patch antenna is limited because the operating bandwidth of a single linearly polarized patch antenna is limited by its input VSWR (Standing Wave Ratio) and it is inversely proportional to the Q factor of the patch resonator. In addition to the above techniques there are some limitations with the same which are listed as follows:

- 1-For probe fed patch antenna an increase in the thickness of substrate causes an increase in probe inductance which in turn creates input matching problems.
- 2-For micro strip fed patches, increased substrate thickness causes an increase junction reactance, which creates spurious radiation as well as input match problem.
- 3-Thick substrates make it mechanically difficult to have antenna arrays conformal to curved surfaces (of aircraft, space craft, missile etc.).
- 4-Many of the analysis and design techniques (cavity model etc.) become inaccurate for thick substrate.

Design with an E-Shaped Patch

By using an E-shaped patch, similar broadband operation can be obtained. The E-shaped patch is formed by inserting a pair of wide slits at the boundary of a microstrip patch.

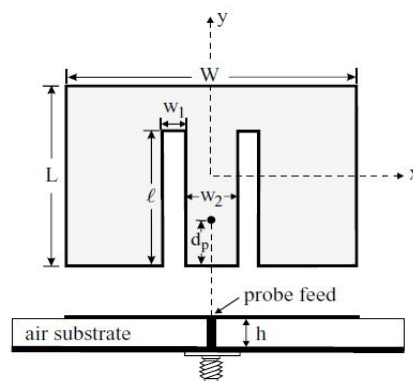

Figure 1. Geometry of a broadband E-shaped microstrip antenna

Non conducting posts of height h (not shown in the figure) from the ground plane. The two wide slits have the same length l and the same width w_1 and are inserted at the bottom edge of the patch. The separation of the two wide slits is w_2 and the two slits are placed symmetrically with respect to the patch's center line (y axis). There are thus only three parameters (l , w_1 , w_2) for the wide slits used here. Along the patch's center line, a probe feed at a distance d_p from the patch's bottom edge can be located for good excitation of the proposed antenna over a wide bandwidth.

III. DESIGN AND SIMULATION

The proposed antenna is designed in the HFSS environment using its efficient CAD tool. The designed antenna is subjected to boundary conditions relevant to the actual environment. By default the HFSS environment has perfectly electric conducting (PEC). Due to this the antenna has to be shielded with Vacuum or Air box to create absorbing boundary conditions. This procedure creates a free space environment. While designing patch antennas the choice of feed plays a major role in defining its efficiency and directivity. Here for simplicity, probe feed technique is employed. Identifying the feed point is another big hurdle. Suitable feed point identification give deeper dips and better VSWR. For the tuning tool in HFSS is used. Using this tool the process of finding solution is repeated again and again for each value of feed point in pre-defined array of feed points. Basing on the results we choose the best feed point. The following Fig. 2 shows the simulated antenna. Discrete solution type for solving is considered over a frequency sweep mentioned in the x-axis of the plots. Though the discrete sweep is time consuming, but tend to provide more accurate results, hence preferred.

International Journal of Advanced Research in Electrical, Electronics and Instrumentation Engineering

(An ISO 3297: 2007 Certified Organization)

Vol. 3, Issue 6, June 2014

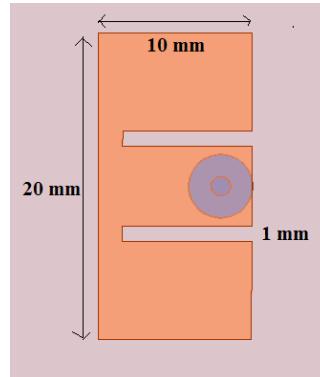

Figure 2. Simulated E shaped antenna.

IV. RESULTS AND DISCUSSION

Basing on the geometry shown the Fig.2 and the solution setup and environment discussed in the previous section various reports are generated. The reflection Coefficient plot is as shown in the Fig.3. The corresponding VSWR is as shown in the Fig.4. The radiation pattern at the two edge frequencies of the bandwidth are presented in the Fig.5 and Fig.6. The frequency vs directivity is as shown in the Fig.7.

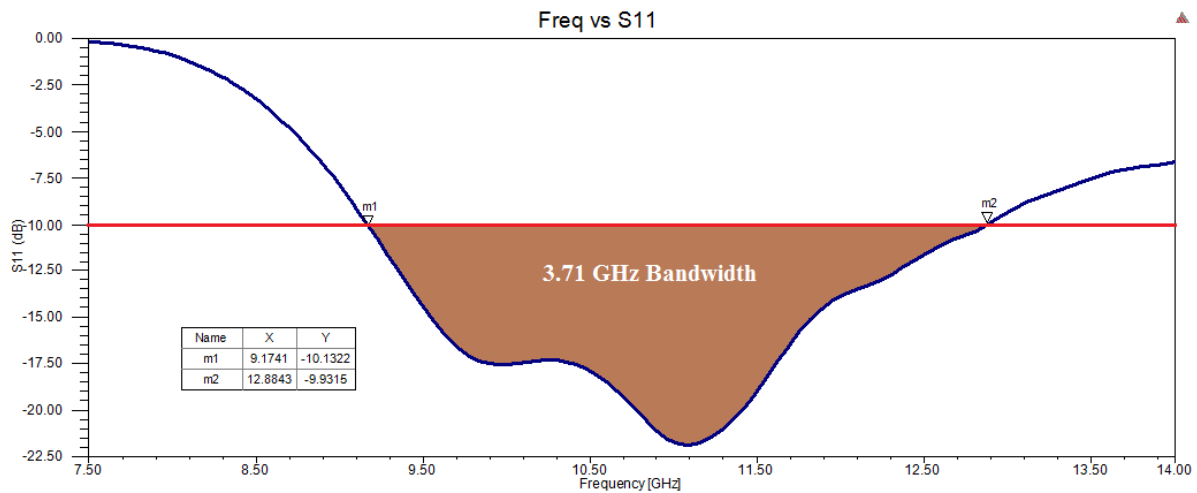

Figure 3. Reflection Coefficient plot

From Fig 3. it can be inferred that the entire band of frequencies between 9.17 GHz and 12.88 GHz show a S11 less than -10dB. Hence the entire region is considered as bandwidth.

International Journal of Advanced Research in Electrical, Electronics and Instrumentation Engineering

(An ISO 3297: 2007 Certified Organization)

Vol. 3, Issue 6, June 2014

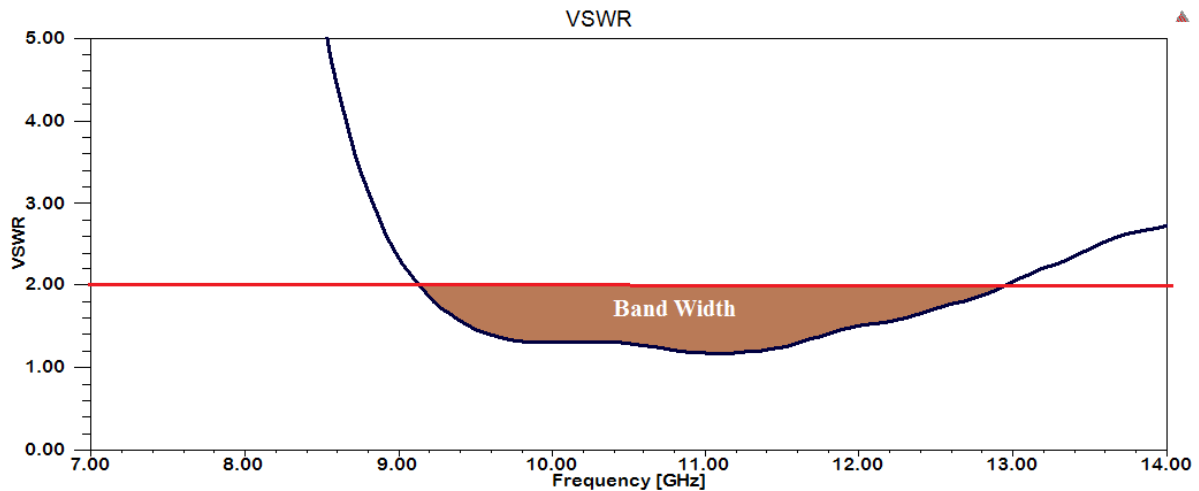

Figure 4. VSWR plot

From the VSWR plot shown in Fig.4 it can be seen that the value of VSWR is below 2 in the same frequency range obtained in Fig.3. Therefore this range of frequencies is concluded to be the bandwidth of the antenna.

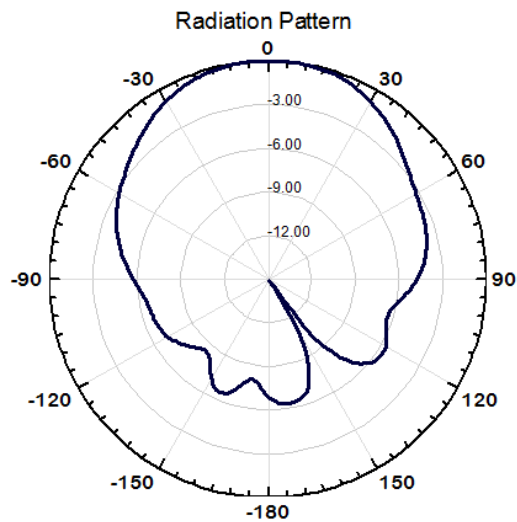

Figure 5. Radiation Pattern at 9.17 GHz

Both edge frequencies are considered for Radiation Pattern. The polar plots of the antenna at these two frequencies and shown in Fig.5 and Fig. 6 respectively. The plots reveal the template radiation pattern of patch antenna.

International Journal of Advanced Research in Electrical, Electronics and Instrumentation Engineering

(An ISO 3297: 2007 Certified Organization)

Vol. 3, Issue 6, June 2014

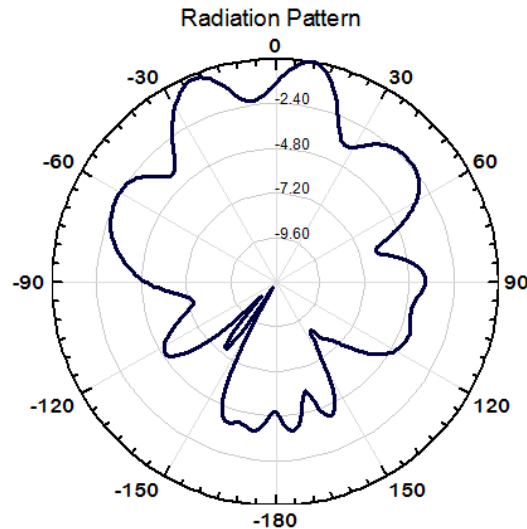

Figure 6. Radiation Pattern at 12.88 GHz

Also the directivity plot in Fig.7 shows a respectable value of D above 6dB for the bandwidth.

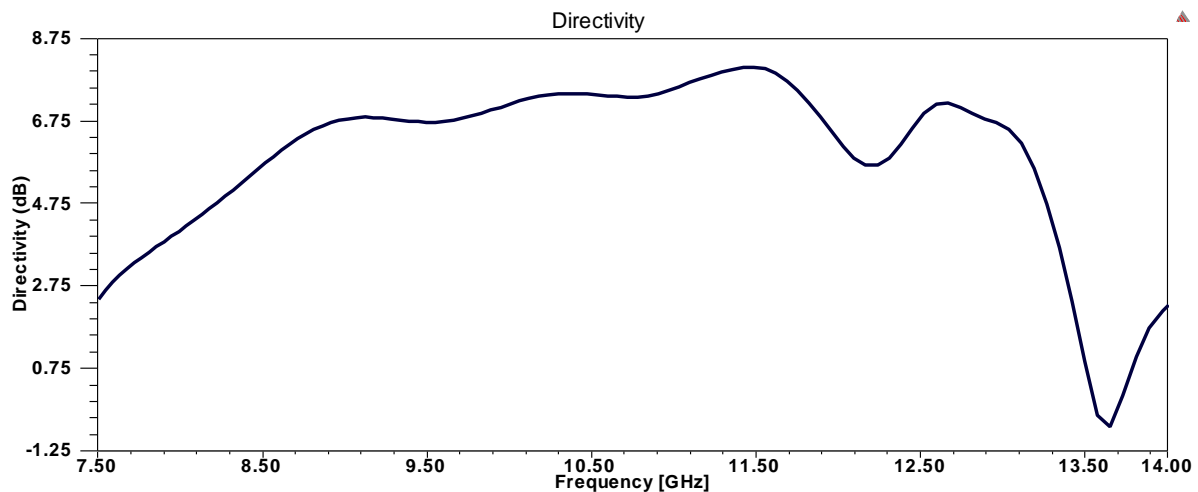

Figure 7. Frequency vs Directivity plot.

V.CONCLUSION

The E shaped pattern on the patch is the reason for multi-resonant characteristics with close in dips in S11 whereas the techniques like low directivity and high substrate height have reduced the gap and resulted in broad band conditions. Validating the results by fabricating the antenna in the real time and taking the results would be a good part of the future work.



ISSN (Print) : 2320 – 3765
ISSN (Online): 2278 – 8875

International Journal of Advanced Research in Electrical, Electronics and Instrumentation Engineering

(An ISO 3297: 2007 Certified Organization)

Vol. 3, Issue 6, June 2014

ACKNOWLEDGEMENTS

The authors would like to acknowledge the support from Sri Raghu Kalidindi, Chairman, Raghu Educational Institutions, Visakhapatnam and the HOD, Department of ECE for the necessary infrastructure to carry out the simulation work.

REFERENCES

- [1] R. Garg, P. Bhartia, I. Bahl, and A. Ittipiboon, *Microstrip Antenna Design Handbook*, ArtechHouse, 2001.
- [2] D. R. Jackson, S. A. Long, J. T. Williams, and V. B. Davis, "Computer- aided design of rectangular microstrip antennas".
- [3] D. M. Pozar, "A reciprocity method of analysis for printed slot and slot- coupled microstrip antennas"
- [4] H. Poes and A Van de Capelle, "Accurate transmission-line model for the rectangular microstrip antenna".
- [5] W. F. Richards, Y. T. Lo, and D. D. Harrison, "An improved theory of microstrip antennas with applications".
- [6] K.M Luk, C.L.Mak, Y.L Chow, K.F Lee, "Broadband Microstrip Patch Antenna" Vol. 34, Issue 15, *Electronic Letters*, July 1998.
- [7] B. L. Ooi and Q. Shen "A novel E-shaped broadband microstrip patch antenna" *Microwave and Optical Technology Letters*, Vol. 27, Issue 6, Dec 2000.
- [8] Ge, Y. Esselle, K.P. ; Bird, T.S. "Broadband E-shaped patch antennas for 5-6 GHz wireless computer networks" Vol. 2, *Antenna and Propagation Society International Symposium*, June 2003
- [9] A.A. Deshmukh and G. Kumar "Compact Broadband E shaped microstrip antenna", *Electronic Letters*, Vol.41, Issue 18, Sep. 2005.
- [10] Yuehe Ge, Karu P Esselle and Trevor S Bird "A Broadband E-shaped patch antenna compatible with microstrip feed" *Microwave and Optical Technology Letters*, Vol. 42, Issue 2, July 2004.